

EXCEPTIONAL HYGIENE



ALWAYS
THE BEST
**PROTECTION
PROFILES**



 **REFLEX**
RESISTANT AND FLEXIBLE

OUR **PENDULUM MACHINE** FOR CRASH REPORTS



RESEARCH AND DEVELOPMENT

CUSTOMISED PROJECT MANAGEMENT SERVICE

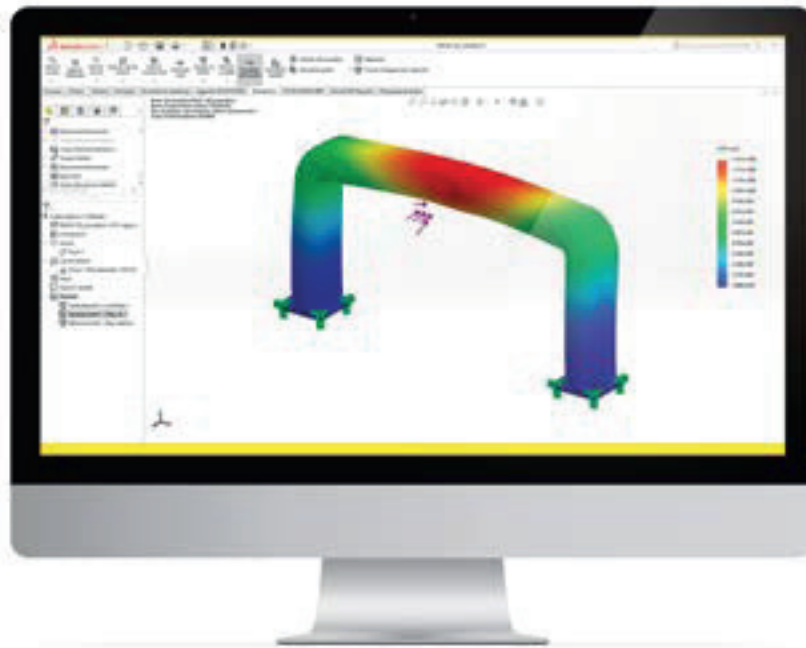

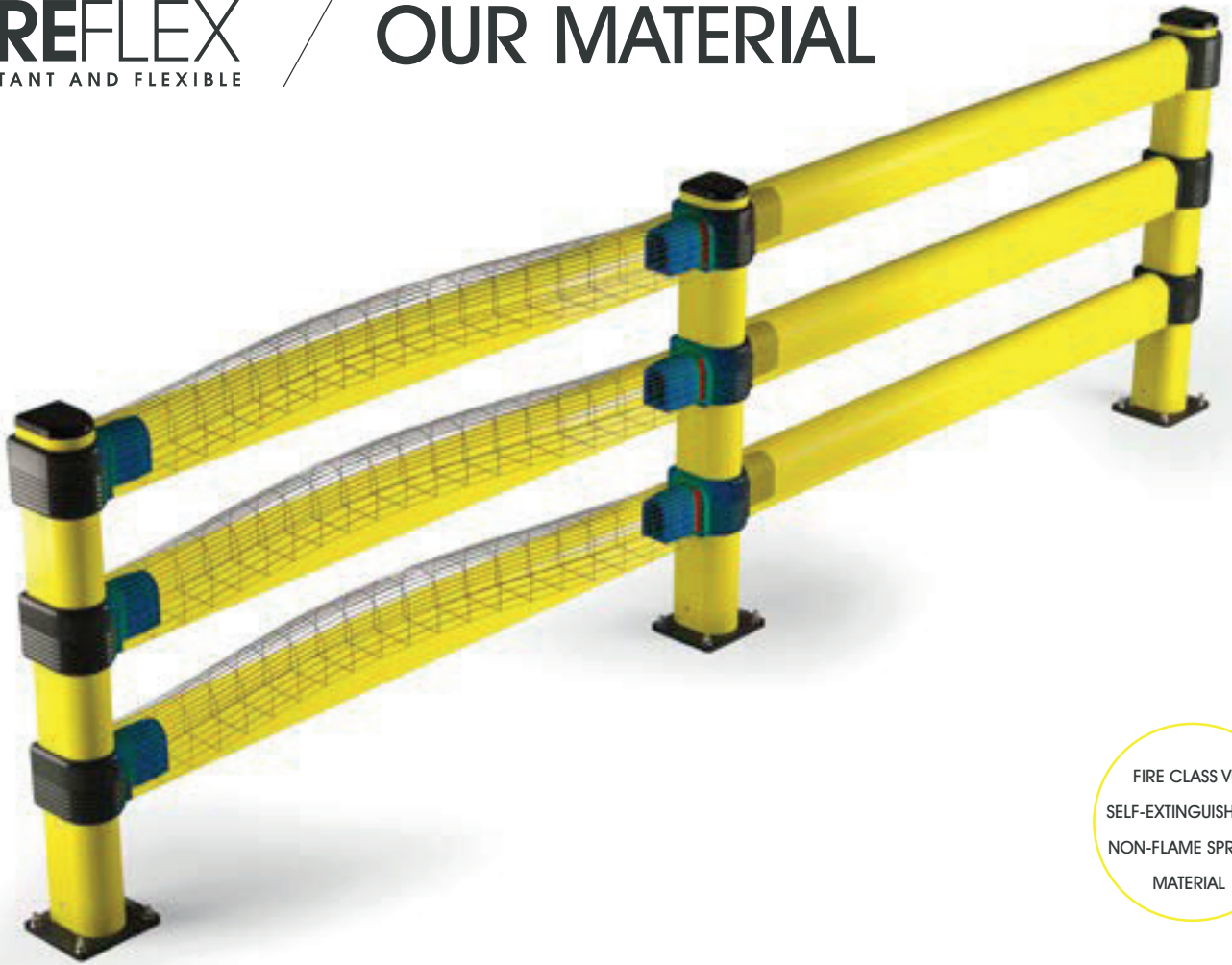





FIRE CLASS V0,
SELF-EXTINGUISHING,
NON-FLAME SPREAD
MATERIAL

FOR FLEXIBLE BARRIER

PROTECTION ARE THE BEST CHOICE IN COMPARISON TO METAL OR OTHER MATERIALS

	 	METAL 	PE/PP 	WOOD 
EASY CLEANING	● ● ● ● ● ●	● ● ● ● ● ○	● ● ● ○ ○ ○	○ ○ ○ ○ ○ ○
SCRATCHES	● ● ● ● ● ●	● ● ● ○ ○ ○	● ● ● ○ ○ ○	● ○ ○ ○ ○ ○
FLEXIBILITY	● ● ● ● ● ●	● ○ ○ ○ ○ ○	● ● ● ● ● ●	● ● ● ○ ○ ○
SHOCK ABSORBER	● ● ● ● ● ●	○ ○ ○ ○ ○ ○	● ● ● ● ● ○	● ● ● ○ ○ ○
FAST INSTALLATION	● ● ● ● ● ●	● ● ● ● ● ●	● ● ● ○ ○ ○	● ● ● ● ● ○
SAVE SPACE	● ● ● ● ● ○	● ● ● ● ● ●	● ● ● ○ ○ ○	● ● ● ● ● ○
FIRE RESISTANT	● ● ● ● ● ○	● ● ● ● ● ●	○ ○ ○ ○ ○ ○	○ ○ ○ ○ ○ ○
LONG LASTING	● ● ● ● ● ●	● ● ● ● ● ●	● ● ● ○ ○ ○	● ● ● ○ ○ ○

NEWS

RESEARCH AND DEVELOPMENT NEVER STOP!

ORANGE LINE

AVAILABLE FOR:
LM / PED 150 /
TOWER

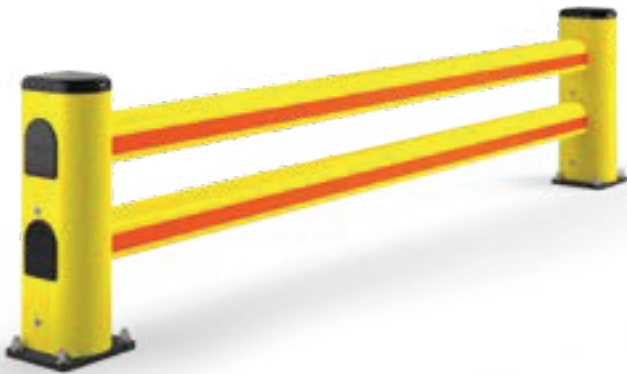

HIGHER
VISIBILITY
FOR A GREATER
SAFETY.

NEWS

RESEARCH AND DEVELOPMENT NEVER STOP!

CLIP 90

AVAILABLE FOR
LM / PED 150 /
TOWER



EASY TO
INSTALL



MORE
VISIBILITY

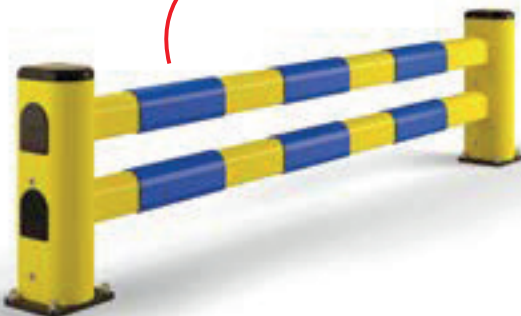

CUSTOMIZE
YOUR BARRIER

GENIUS

THE LENGTH THAT YOU WISH

CUT THE RAIL AND DRILL IT WITH GENIUS 

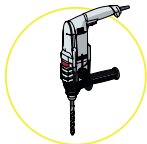

WORLD'S UNIQUE SYSTEM 
YOUR CUSTOMIZED BARRIER AND HUG TOWER

SAFETY TOTEM

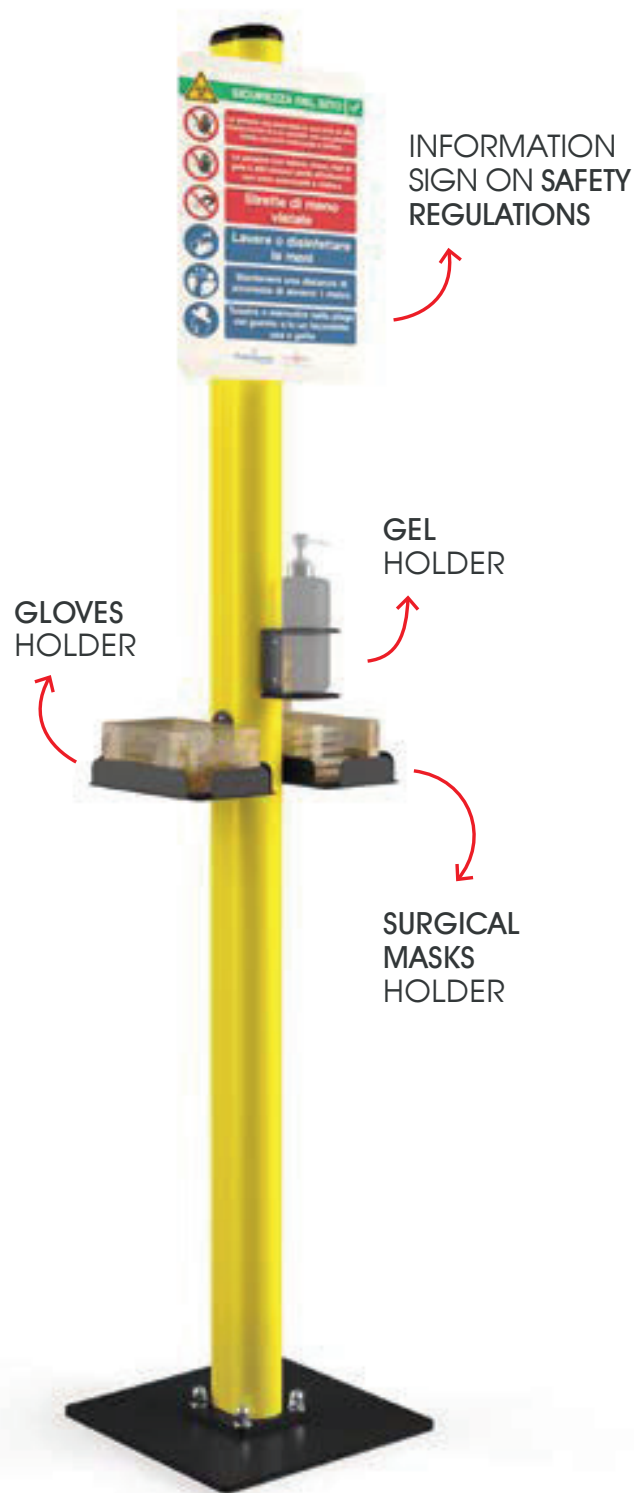

AVAILABLE IN **FOUR** VERSIONS

01

RACK PROTECTION

OUR PROFILES FIT ALL RACKS

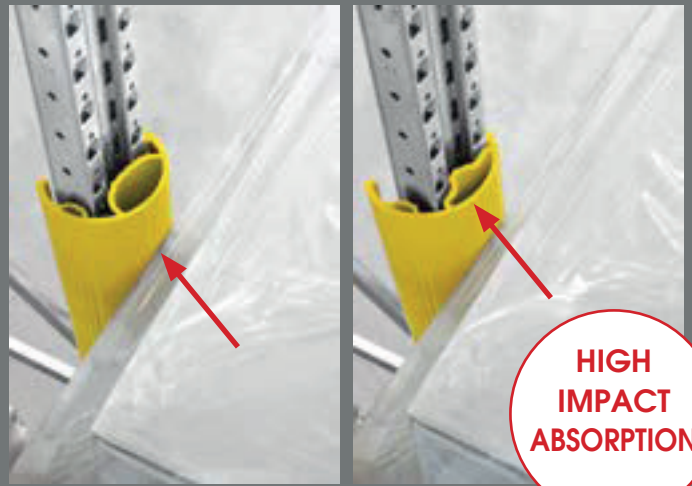

Full range of techno polymer profiles for protection of warehouse racks.

Gamma completa di profili in tecnopolimeri per la protezione di scaffali.

Complète gamme de profilés en tecnopolimère pour la protection d'„étagères de dépôts.

Gama completa de periles de tecnopolimeros para las protecciones de estanterías.





EASY TO INSTALL

THE ONLY ONE WITH TRIPLE SHOCK ABSORBER

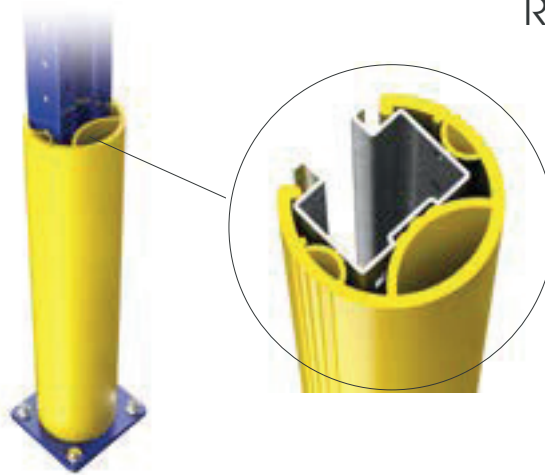

RPS 600

60 80

ANTISHOCK MATERIAL INSIDE

Packing 6 pz / box
Packing 114 pz / big parcel
Colour M

Available also size 400



RPM 600

80 100

ANTISHOCK MATERIAL INSIDE

Packing 4 pz / box
Packing 80 pz / big parcel
Colour M

Available also size 400

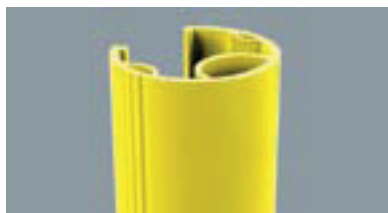
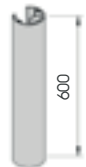

RPL 600

100 120

ANTISHOCK MATERIAL INSIDE

Packing 2 pz / box
Packing 54 pz / big parcel
Colour M

Available also size 400

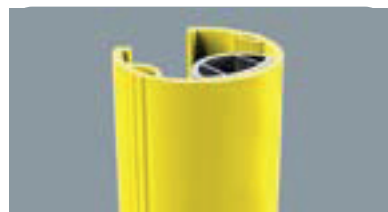
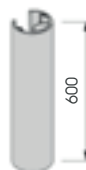

RPL XL 600

100 120

ANTISHOCK MATERIAL INSIDE

Packing to be defined
Colour M

Available also size 400

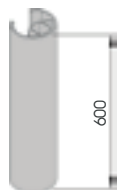

RP CLICK

Packing 1 pz / box

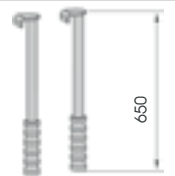

RPF 600

60 130

FLEXIBLE

Packing 2 pz / bag
Colour M

Axle spacing 25 - 50 - 75 mm

Equipped with accessories

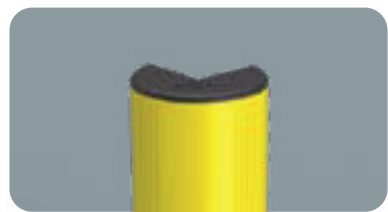
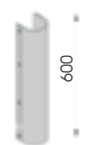

RACK CORNER

ANTISHOCK MATERIAL INSIDE

Packing to be defined
Colour M

Equipped with accessories

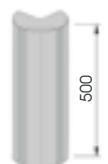

Rack end Barriers

SM



DIFFERENT SIZES ON REQUEST

FAST AND EASY TO INSTALL

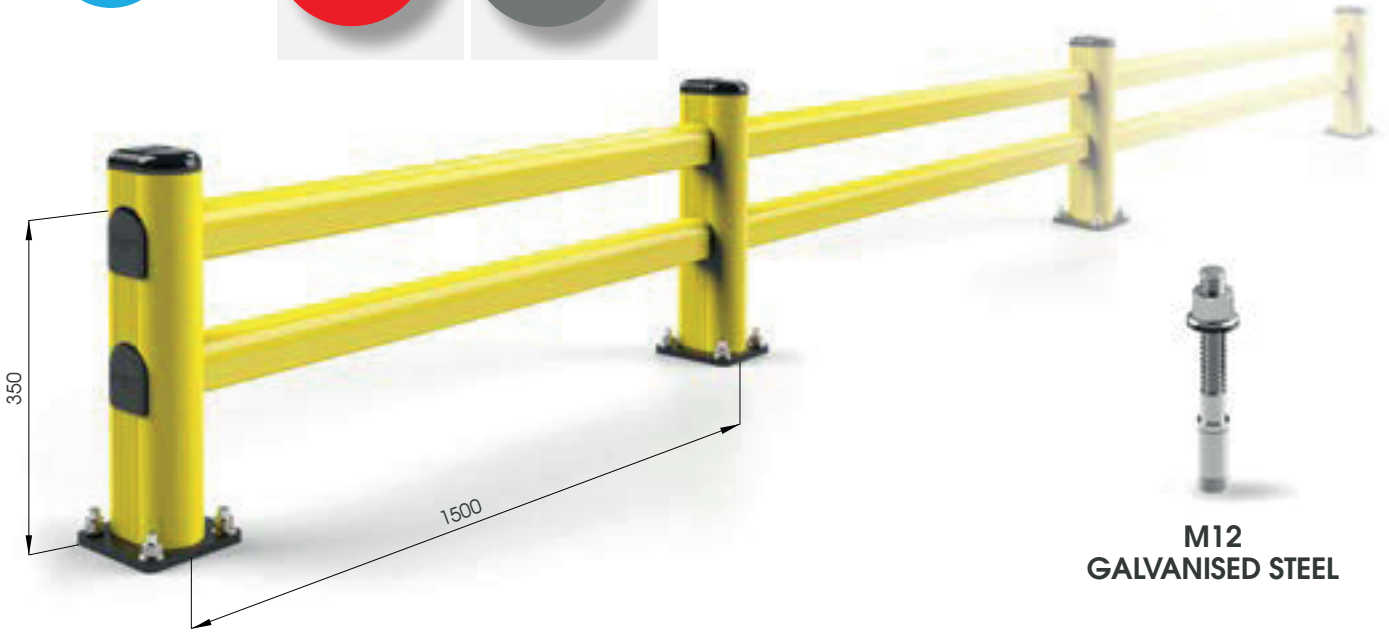

M12 GALVANISED STEEL



SM 1500x400 MODULAR

Packing: unpacked on pallet
Colour: B M

Equipped with accessories

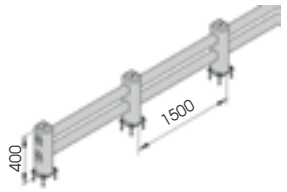

SM 1100x400

Length: 1.100
Packing: unpacked on pallet
Colour: B M

Equipped with accessories

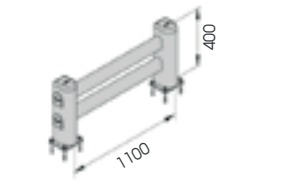

Rack end Barriers

LM



DIFFERENT SIZES ON REQUEST

FAST AND EASY TO INSTALL

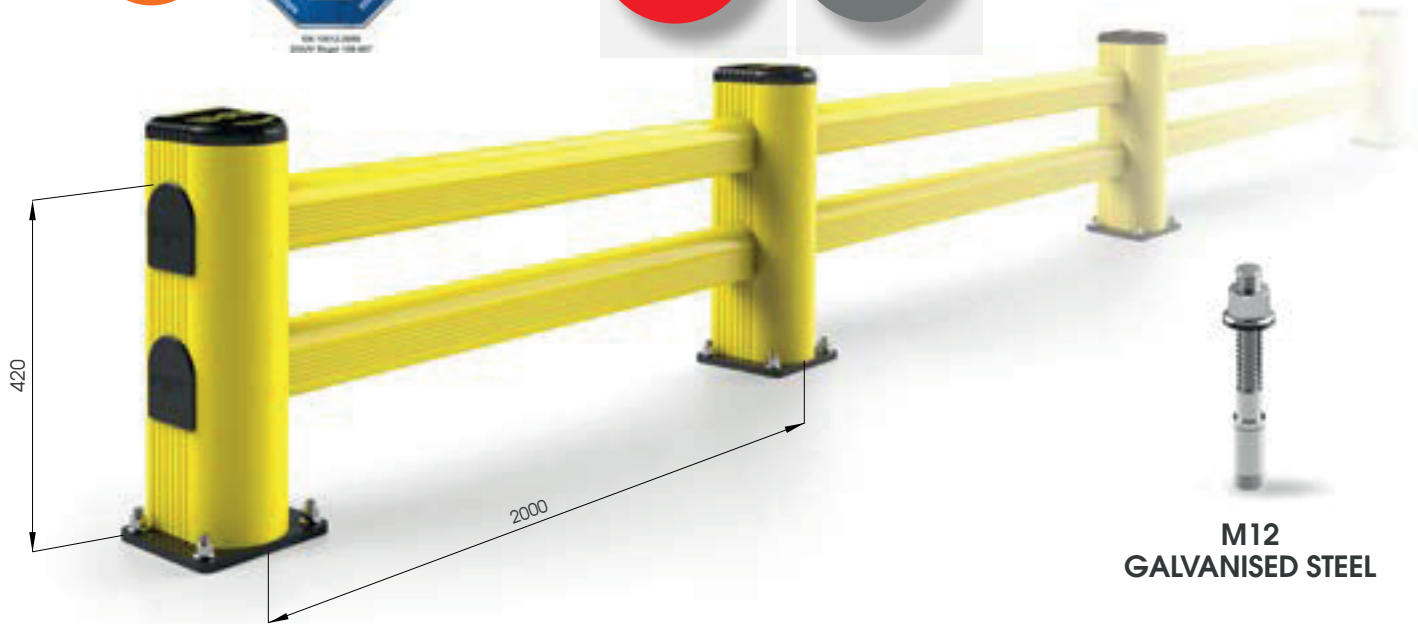

M12 GALVANISED STEEL



LM 2000x500 MODULAR

Packing Colour **unpacked on pallet**
 B M

Equipped with accessories

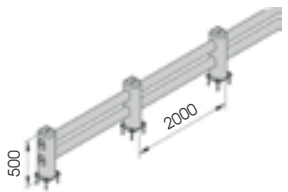

**LM 1100x500
LM 2400x500**

Length **1.100 / 2.400 mm**
 Packing Colour **unpacked on pallet**
 B M

Equipped with accessories

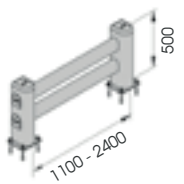

Rack end Barriers

FENCE 90



DIFFERENT SIZES ON REQUEST

FAST AND EASY TO INSTALL



M12 GALVANISED STEEL



FE 90 1100x350

Length **1.100 mm**
 Packing **unpacked on pallet**
 Colour **B M**

Equipped with accessories

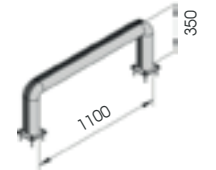

FE 90 2400x350

Length **2.400 mm**
 Packing **unpacked on pallet**
 Colour **B M**

Equipped with accessories

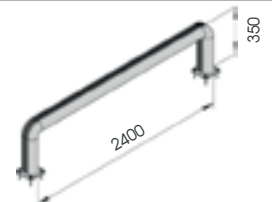

FENCE 150



DIFFERENT SIZES ON REQUEST

FAST AND EASY TO INSTALL



M12 GALVANISED STEEL



FE 150 1100x550

Length 1.100 mm
Packing unpacked on pallet
Colour B M

Equipped with accessories



FE 150 2400x550

Length 2.400 mm
Packing unpacked on pallet
Colour B M

Equipped with accessories



Rack end Barriers

FENCE 150 REINFORCED



DIFFERENT SIZES ON REQUEST

FAST AND EASY TO INSTALL



M12 GALVANISED STEEL



FE 150 REF 1100x550

Length **1,100 mm**
 Packing **unpacked on pallet**
 Colour **B** **V**



Equipped with accessories



FE 150 REF 2400x550

Length **2,400 mm**
 Packing **unpacked on pallet**
 Colour **B** **V**



Equipped with accessories



FENCE LINK



DIFFERENT SIZES ON REQUEST

FAST AND EASY TO INSTALL

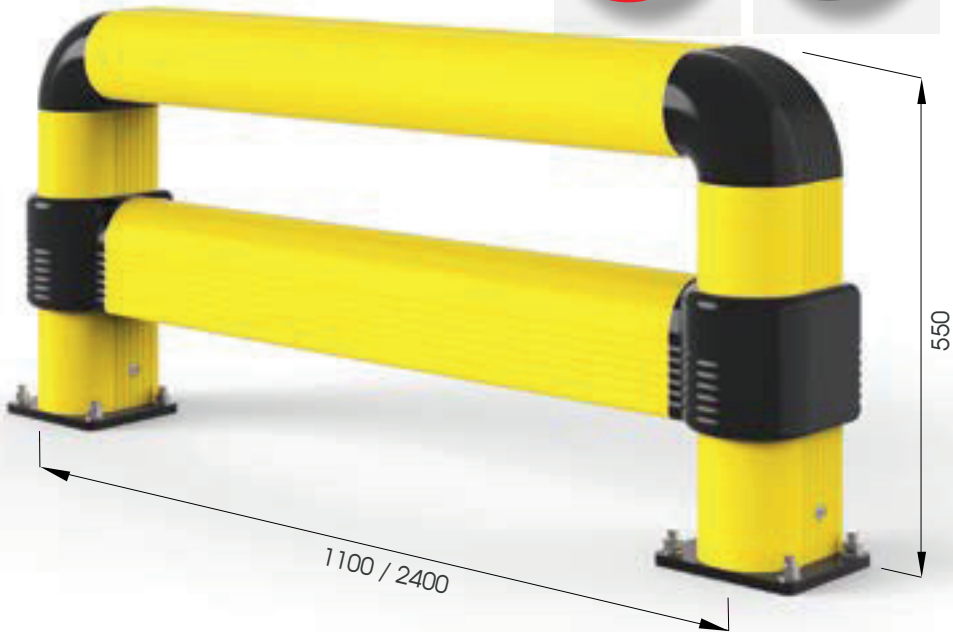

M12 GALVANISED STEEL



FE LINK 1100x550

Length 1.100 mm
Packing unpacked on pallet
Colour B M

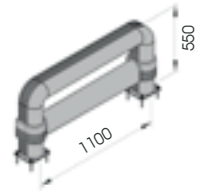

Equipped with accessories



FE LINK 2400x550

Length 2.400 mm
Packing unpacked on pallet
Colour B M

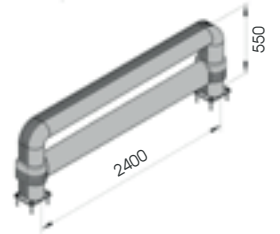

Equipped with accessories



02

BOLLARD

Designed to protect access to gates or big doors from huge traffic or simply to mark restricted areas for pedestrians. Fully equipped with fixing accessories.

Ideato per proteggere l'accesso a cancelli o portoni dalla movimentazione di mezzi pesanti o semplicemente per impedire l'ingresso di pedoni. Provvisto di accessori di fissaggio.

Étudié pour protéger l'accès aux portes ou entrées de grand trafic ou simplement pour marquer les zones de passage piétons. Equipé avec les accessoires d'installation.

Diseñado para proteger el acceso a puertas o portones del movimiento de vehículos pesados o simplemente para evitar la entrada de peatones. Provisto de accesorios de fijación.



GRD 90



Bollard

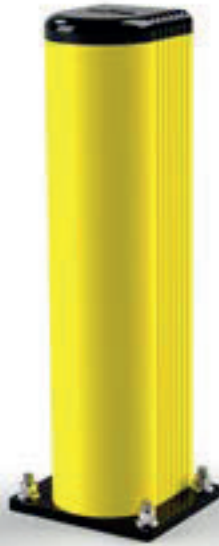

**M12
GALVANISED STEEL**



GRD 90 250

Packing **unpacked on pallet**
Colour **B** **M**

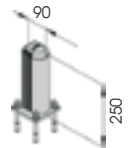

Equipped with accessories



GRD 150



Bollard

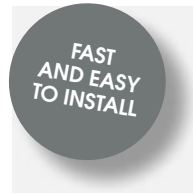

**M12
GALVANISED STEEL**



**GRD 150 * 500
800
1150**

Packing
Colour **unpacked on pallet**

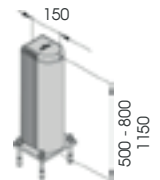

Equipped with accessories



GRD 200

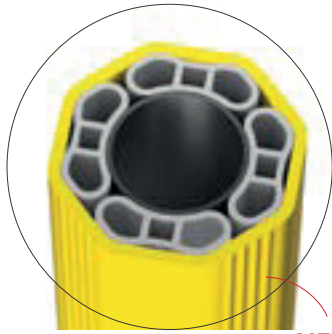

**NEW
ANTISHOCK
BUMPER**

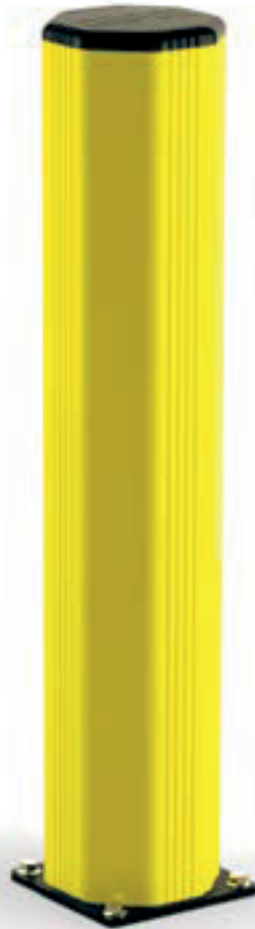

INCLUDED

Bollard

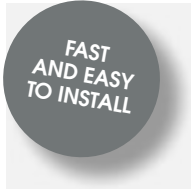

**S16
GALVANISED STEEL**



**GRD 200 1200
2000**

Equipped with accessories

Packing Colour **unpacked on pallet**
Colour **M**



03

GUARD RAILS

A new bumper system specific for the protection of the walls resistant against trolleys movements. Designed by following an innovative technical design that combines speed and simplicity in the steps of installation and cleaning. Available in different lengths.

Sistema prolli antiurto specifico per la protezione delle pareti dai carrelli in movimento. Progettato seguendo un innovativo disegno tecnico che coniuga rapidità e semplicità nelle fasi di installazione e pulizia. Disponibile in diverse lunghezze.

Nouveau système bumper, spécifique pour protéger les murs contre les mouvements des charriots. Étudié avec un modern dessin qui regroupe la rapidité et la facilité pendant l'installation et le nettoyage. Disponible en différents longueurs.

Sistema de periles anti-impacto específico para la protección de las paredes de los carros en movimiento. Diseñado según un diseño técnico innovador que une velocidad y simplicidad en las fases de instalación y limpieza. Disponible en diferentes longitudes.



TRUCK LINE



DIFFERENT SIZES ON REQUEST

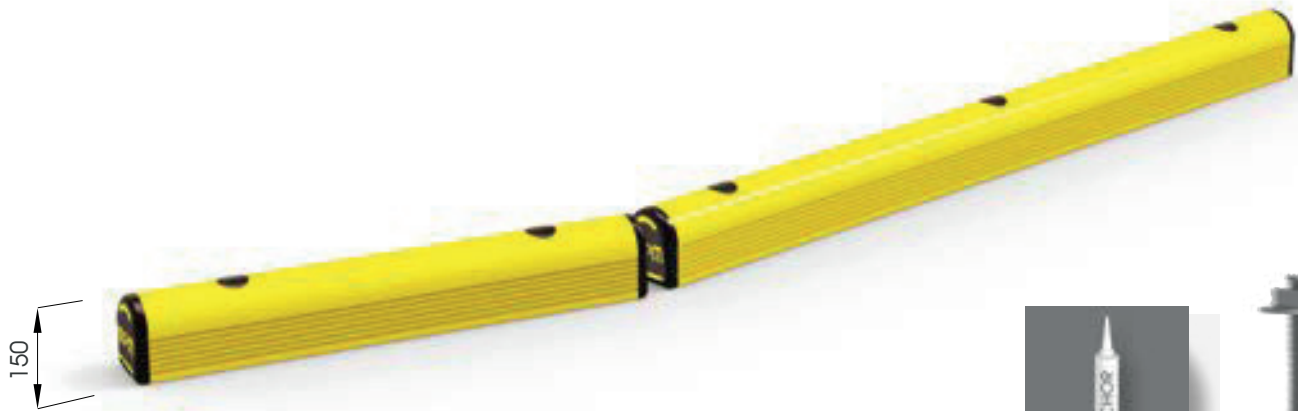

TL	500	2000
	750	3000
	1000	4000
	1500	

Equipped with accessories

Packing Colour **to be defined**



Guard Rails

GUARD RAIL 90



M16 GALVANISED STEEL

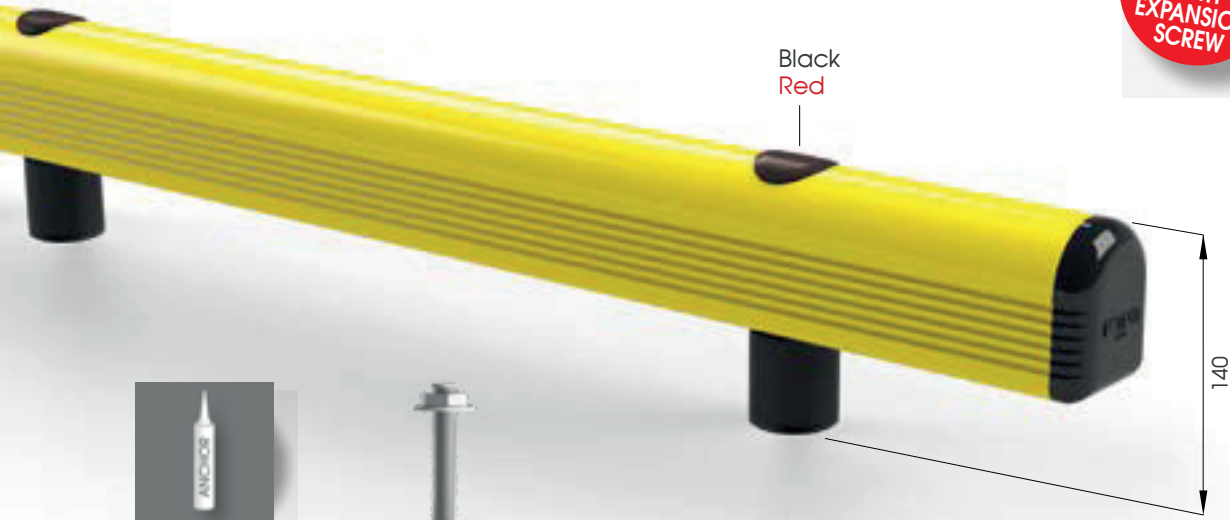

ALTERNATIVE FIXING
HIGH RESISTANCE WITH RESIN

M16 STAINLESS STEEL



GR 90 500
750
1000
1500

Length 500 mm
Packing unpacked on pallet

Length 750 / 1000 / 1500 mm
Packing 2 pz / box

Colour B M

Equipped with accessories

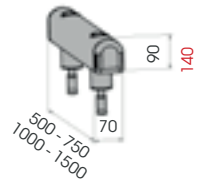

GR 90 2000
3000
4000

Length 2.000 / 3.000 / 4.000 mm
Packing unpacked on pallet
Colour B M

Equipped with accessories

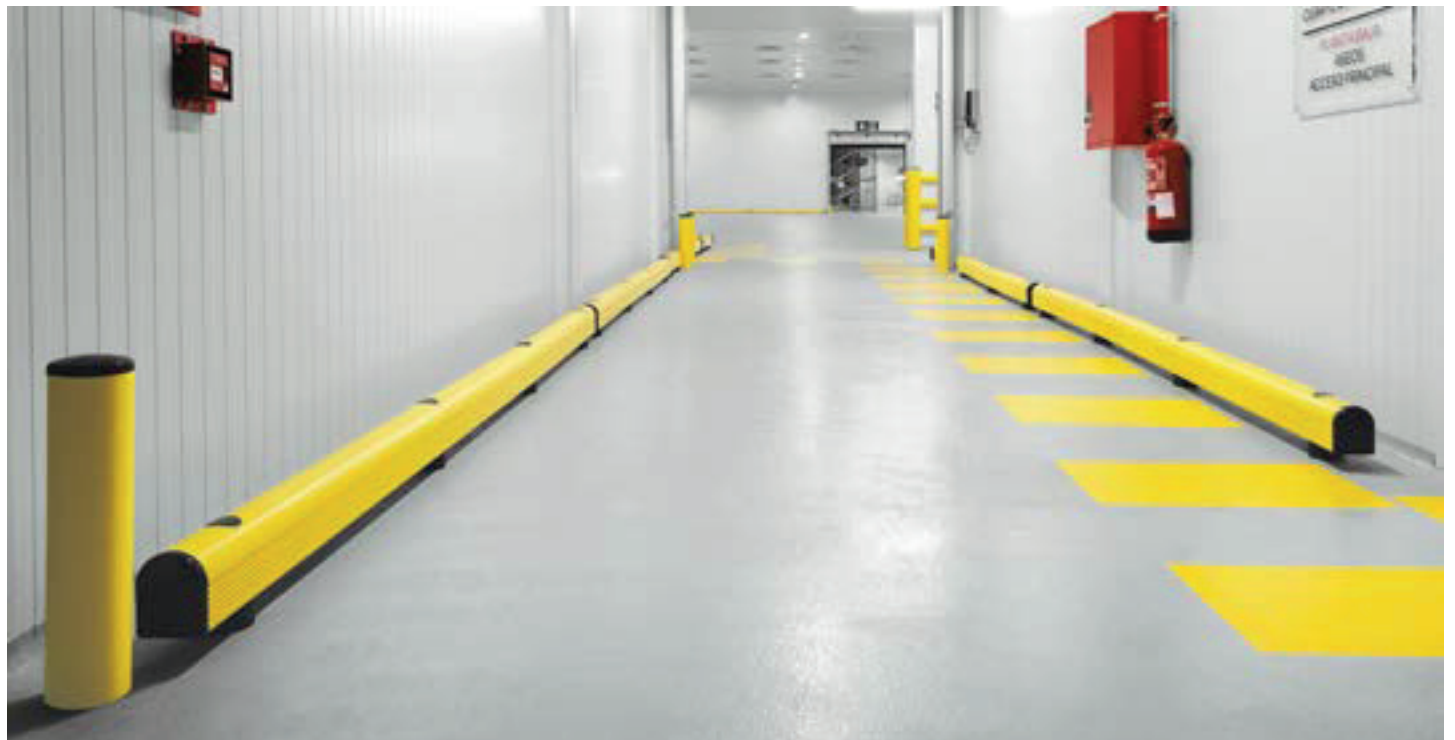
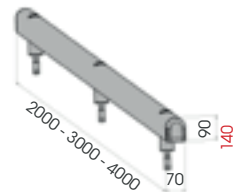

GUARD RAIL 150



SF20
STAINLESS STEEL

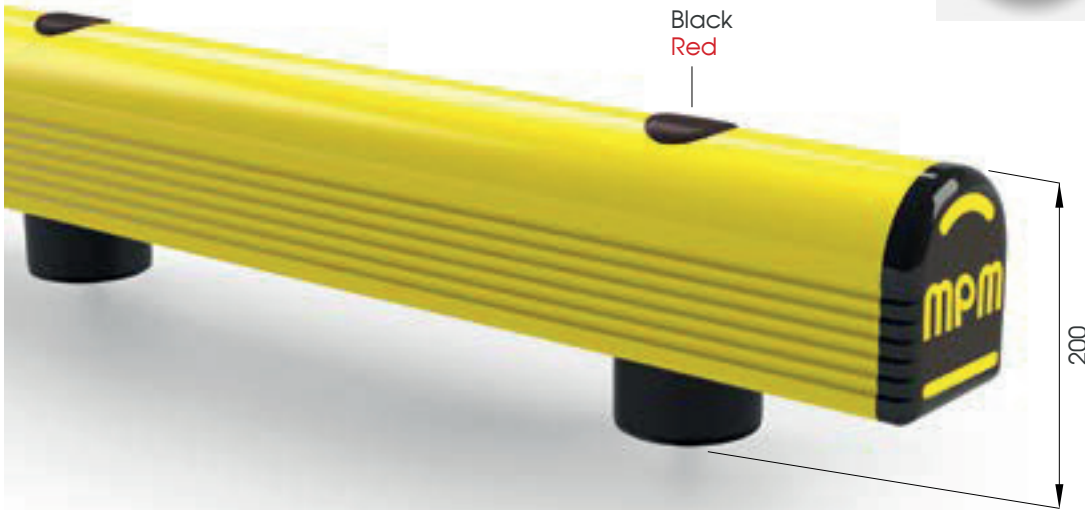

GR 150 500
750
1000
1500

Length 500 / 750 /
1000 / 1500 mm
Packing unpacked on pallet
Colour B M

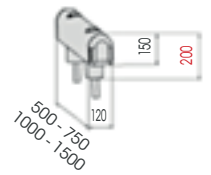

Equipped with accessories



GR 150 2000
3000
4000

Length 2.000 / 3.000 / 4.000 mm
Packing unpacked on pallet
Colour B M

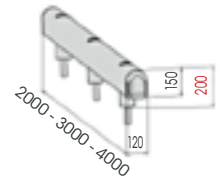

Equipped with accessories

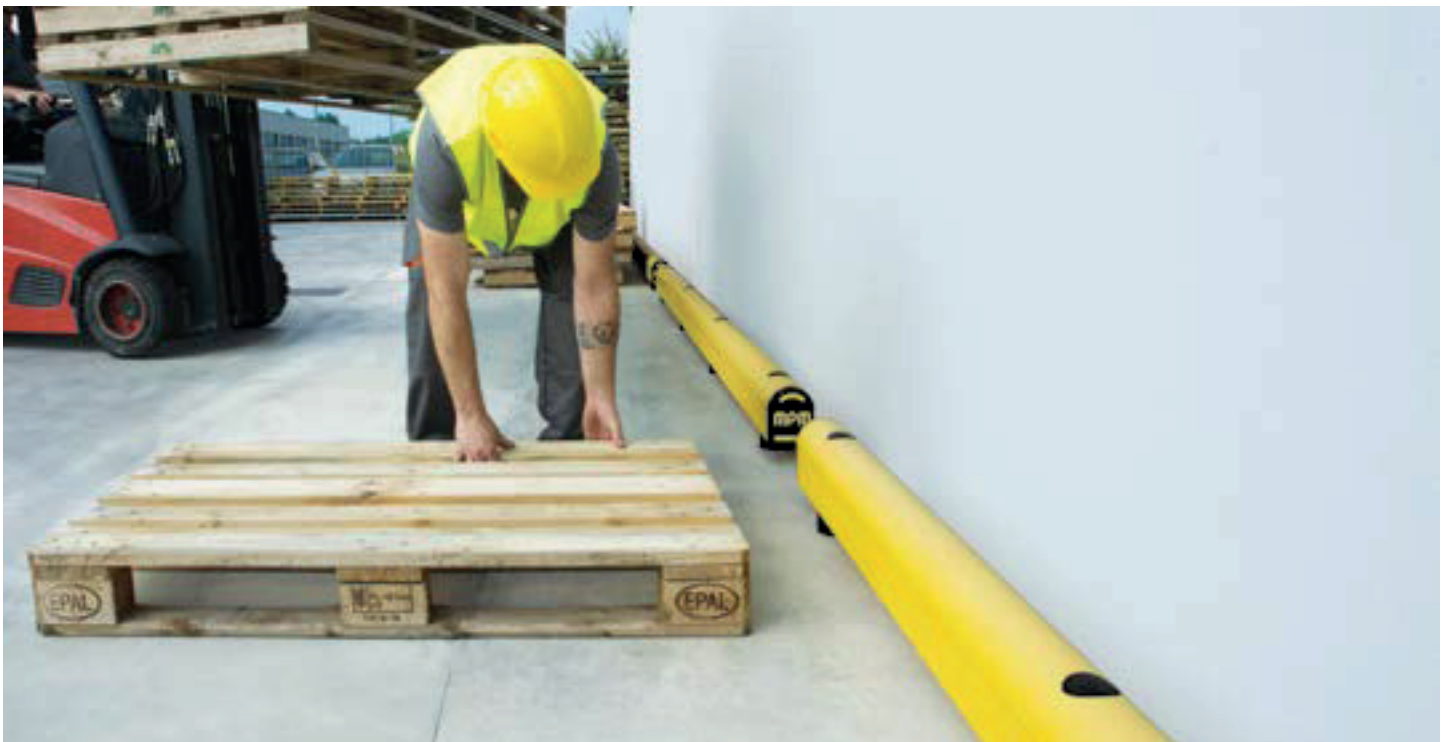

Guard Rails

GRIN 90

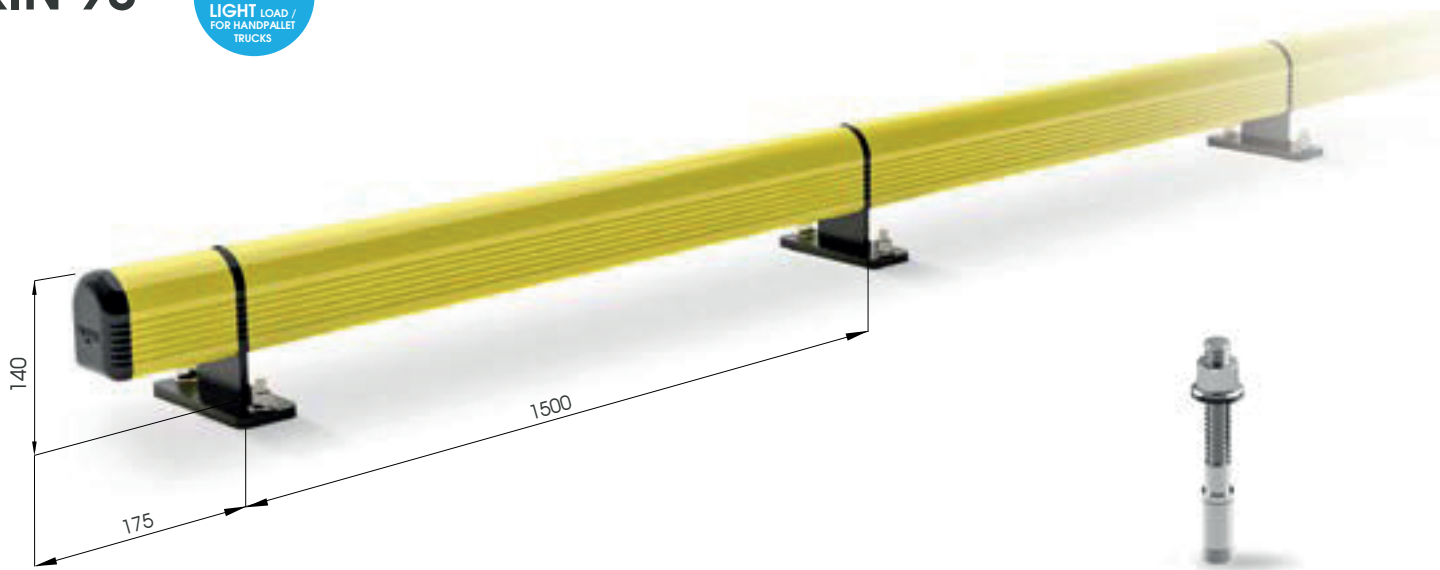

**M12
GALVANISED STEEL**



GRIN 90 1500

Length **1500 mm**
Packing **to be defined**
Colour **M**

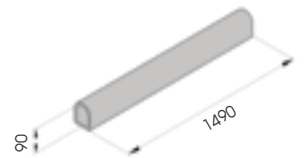

GRINCO 90

Packing **to be defined**
Colour **M**



Equipped with accessories



GRINT 90

Packing **to be defined**
Colour **M**

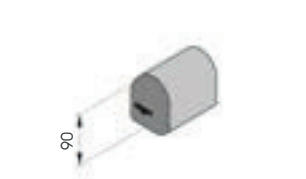

Equipped with accessories



GRIN 150



M12 GALVANISED STEEL



GRIN 150 2000

Length **2000 mm**
Packing **to be defined**
Colour **M**

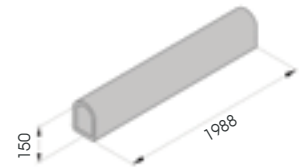

GRINCO 150

Packing **to be defined**
Colour **M**



Equipped with accessories



GRINT 150

Packing **to be defined**
Colour **M**

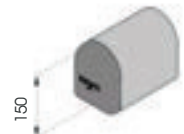

Equipped with accessories



04

COLD LINE

Specific solutions for the protection of areas at risk of impact, in environments with negative temperature. They are suitable to protect corners, entrances, gates, panels and cold rooms walls.



Soluzioni specifiche per la protezione di zone a rischio d'„impatto in ambienti a temperatura negativa. Ideali per proteggere angoli sporgenti, accessi e portoni, pannelli e pareti di celle frigorifere.

Solutions spécifiques pour la protection des zones à risque de collision dans les environnements à température négative. Idéal pour protéger les angles, les entrées et les portes, les panneaux et les murs des chambres froides.

Soluciones específicas para proteger las zonas con riesgo de impacto en entornos de temperatura negativa. Son ideales para proteger esquinas, entradas y puertas, paneles y paredes de las cámaras frigoríficas.

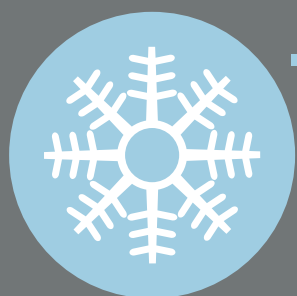

-30°

RESISTANT
TO LOW
TEMPERATURES



Cold Line

ROD 70



LIGHT LOAD /
FOR HANDPALLET
TRUCKS

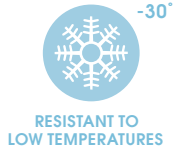

M20
GALVANISED STEEL

Fixing accessory available also in stainless steel



ROD PE 70 266 RE

Packing
Colour

1 pz / box



Drill \varnothing 38
Equipped with accessories

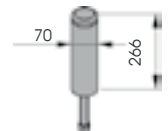

ROD 120



Cold Line

RE
EASY TO
REMOVE AND
TO REPLACE

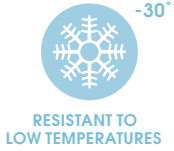

**M30
GALVANISED STEEL**

Fixing accessory available also in stainless steel



**ROD PE 120 433 RE
560 RE
800 RE**

Packing
Colour **1 pz / bag**
M

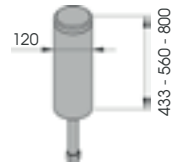

Drill Ø 56
Equipped with accessories



Cold Line

ROD FLOOR 70



**QUICK
INSTALLATION
WITH
EXPANSION
SCREW**



**M16
GALVANISED STEEL**

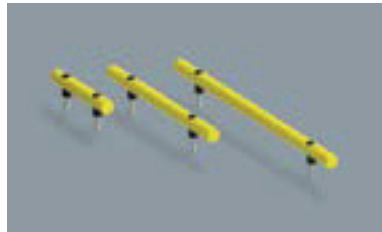
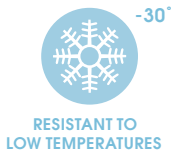

RF 70 500
1000
1500

Length 500 / 1000 / 1500 mm
Packing unpacked on pallet
Colour M

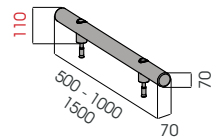

Equipped with accessories



RF 70 2000
3000

Length 2.000 / 3.000 mm
Packing unpacked on pallet
Colour M

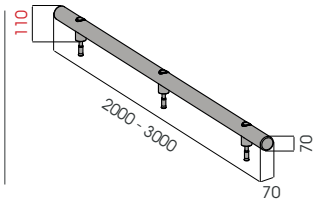

Equipped with accessories



ROD FLOOR 120



SF20
STAINLESS STEEL

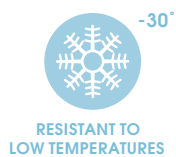
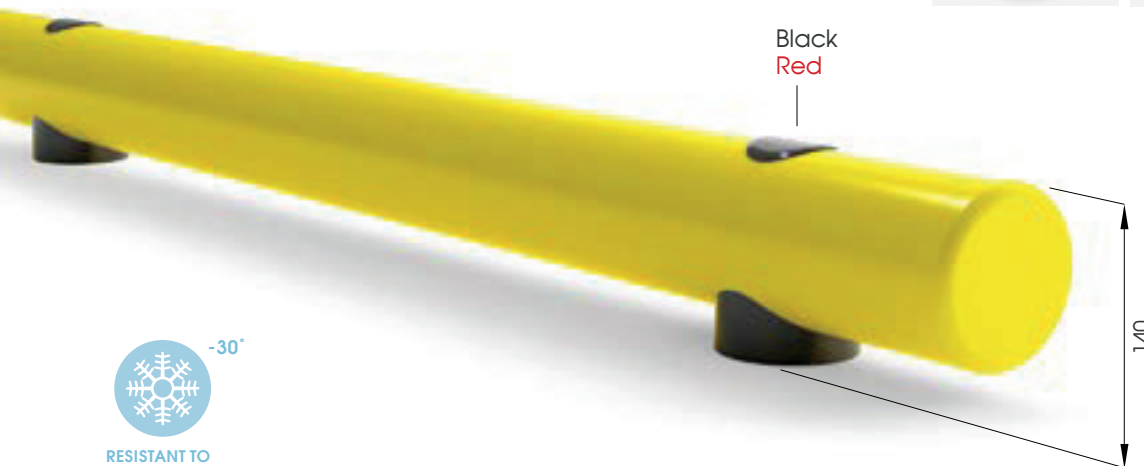

RF 120 500
1000
1500

Length 500 / 1000 / 1500 mm
Packing unpacked on pallet
Colour M

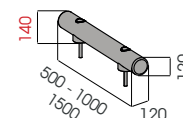

Equipped with accessories



RF 120 2000
3000

Length 2.000 / 3.000 mm
Packing unpacked on pallet
Colour M

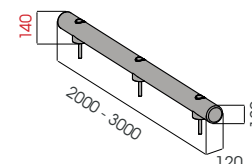

Equipped with accessories

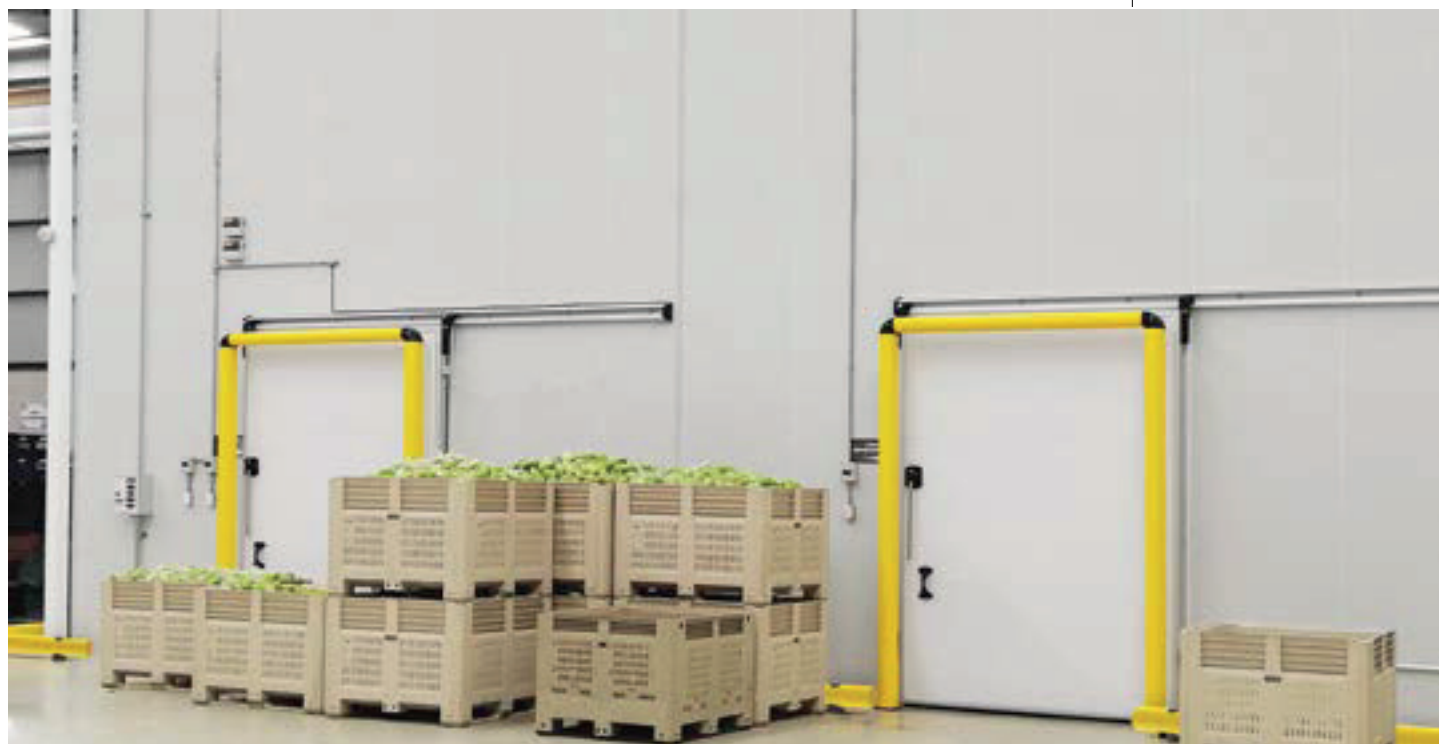

05

PEDESTRIAN SAFETY BARRIERS

A new protection system specific for the protection of pedestrians and resistant to trolleys movements with different load types. Designed by following an innovative technical design that combines speed and simplicity in the steps of installation and cleaning. Available in different lengths.

Sistema di profili antiurto specifico per la protezione delle aree pedonali dai carrelli in movimento con diverse portate di carico. Progettato seguendo un innovativo disegno tecnico che coniuga rapidità e semplicità nelle fasi di installazione e pulizia. Disponibile in diverse lunghezze.

Nouveau système bumper, spécifique pour protéger les zones piétonnes contre les mouvements des charriots. Étudié avec un modern dessin qui regroupe la rapidité et la facilité pendant l'installation et le nettoyage. Disponible en différents longueurs.

Sistema específico de perfiles antichoque para la protección de zonas peatonales de carros en movimiento con diferentes capacidades de carga. Diseñado según un diseño técnico innovador que une velocidad y simplicidad en las fases de instalación y limpieza. Disponible en diferentes longitudes.



HAND RAIL 90



FAST AND EASY TO INSTALL

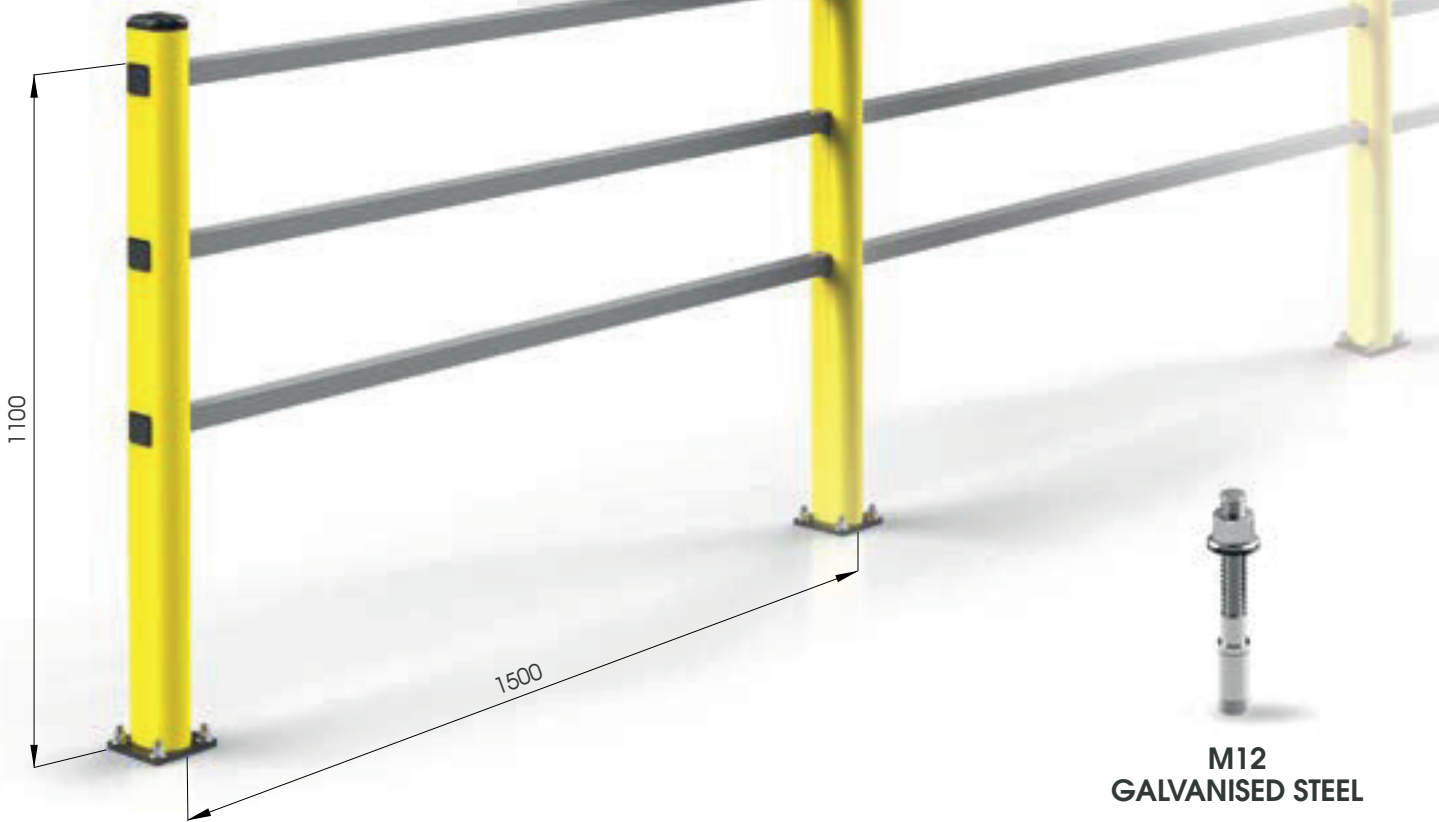

M12 GALVANISED STEEL

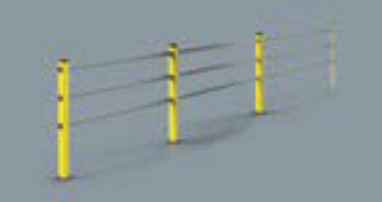

HR 90 1500x1150 MODULAR

Equipped with accessories

Packing Colour **unpacked on pallet**

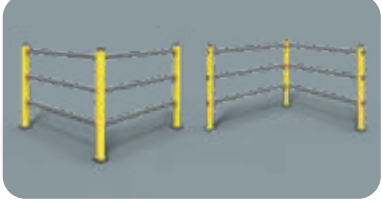
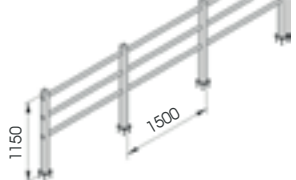

HR 90 1500x1150 CORNER

Equipped with accessories

Packing Colour **unpacked on pallet**

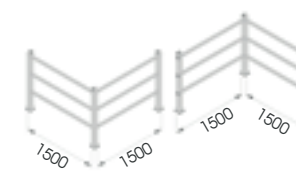

Pedestrian Safety Barriers

PEDESTRIAN 90



FAST AND EASY TO INSTALL



M12 GALVANISED STEEL



PED 90 1500x1150 MODULAR

Packing Colour **unpacked on pallet**
 B M



Equipped with accessories



PED 90 1500x1150 CORNER

Packing Colour **unpacked on pallet**
 B M

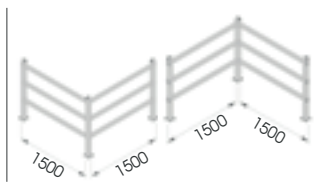

Equipped with accessories



PEDESTRIAN 150



FAST AND EASY TO INSTALL



PED 150 2000x1150 MODULAR

Packing Colour **unpacked on pallet**
 B M

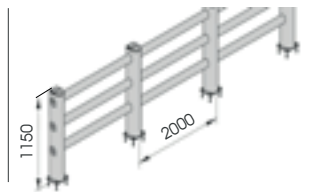

Equipped with accessories



PED 150 2000x1150 CORNER

Packing Colour **unpacked on pallet**
 B M

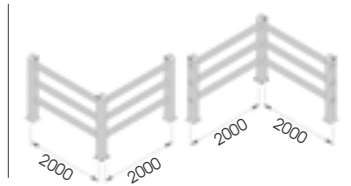

Equipped with accessories

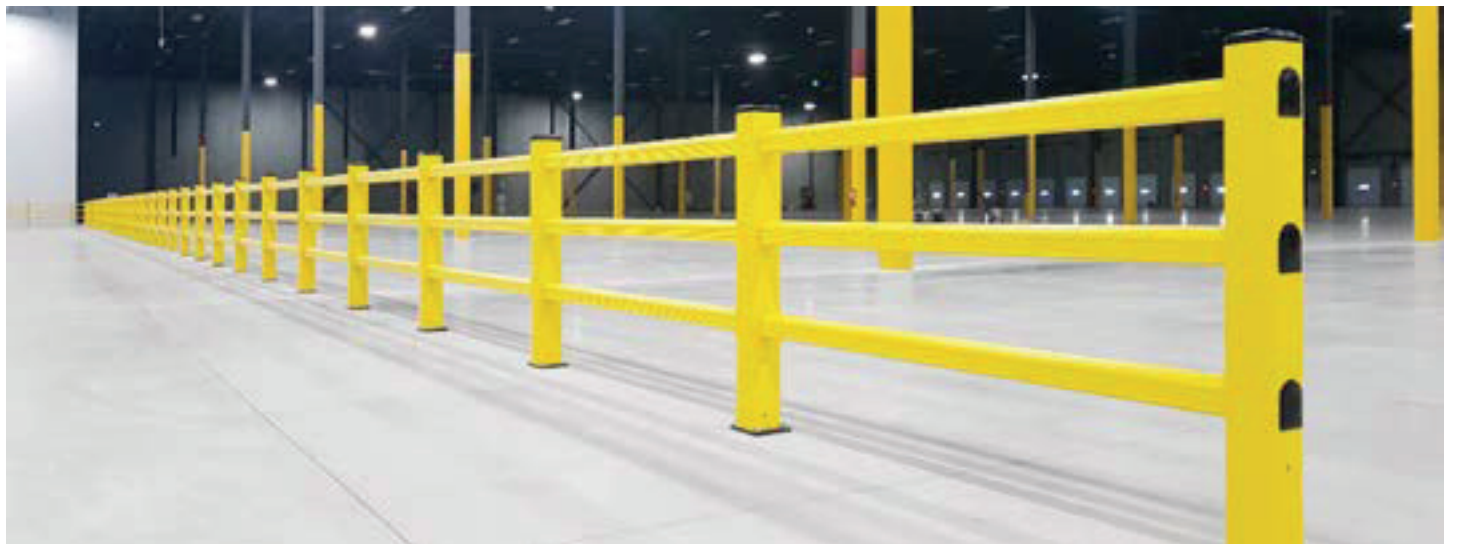

PEDESTRIAN 90 REINFORCED



M12 GALVANISED STEEL



PED 90 REF MODULAR

Equipped with accessories

Packing **unpacked on pallet**
Colour **B M**

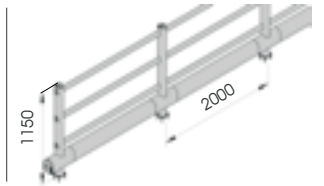

PEDESTRIAN 150 REINFORCED LINK



FAST AND EASY TO INSTALL



M12 GALVANISED STEEL



PED 150 REF LINK

Equipped with accessories

Packing Colour **unpacked on pallet**



06

DOORS

Safety gate system with different opening possibilities, ideated to be installed on our pedestrian barriers. Designed by following an innovative technical design that combines speed and simplicity in the steps of installation and cleaning. Available in different opening systems.

Sistema di cancelli antiurto ideati per l'installazione nelle nostre barriere di protezione per aree pedonali. Progettati seguendo un innovativo disegno tecnico che coniuga rapidità e semplicità nelle fasi di installazione e pulizia. Disponibili molteplici sistemi di apertura.

Système de portillons résistant aux chocs étudié pour l'installation de nos barrières de protections pour les zones piétons. Portillons conçus suivant un design innovant qui combine rapidité et simplicité pendant le montage et le nettoyage. Différents systèmes d'ouvertures disponibles.

Sistema de puertas antigolpe diseñadas para la instalación de nuestras barreras de protección para áreas peatonales. Diseñado según un diseño técnico innovador que une velocidad y simplicidad en las fases de instalación y limpieza. Están disponibles varios sistemas de apertura.



Full frame

FULL FRAME



DIFFERENT SIZES ON REQUEST

FAST AND EASY TO INSTALL

OPTION: WALL FIXING ACCESSORIES

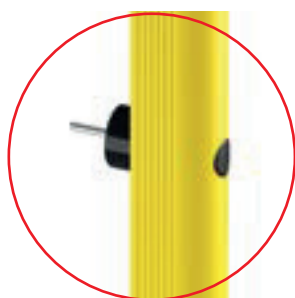

NEW BIGGER PLATES!

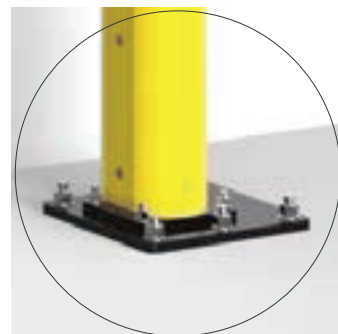

M16 STAINLESS STEEL



FFB

Packing Colour **to be defined**

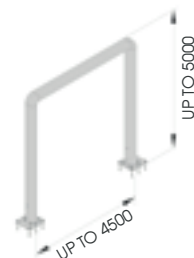

Equipped with accessories

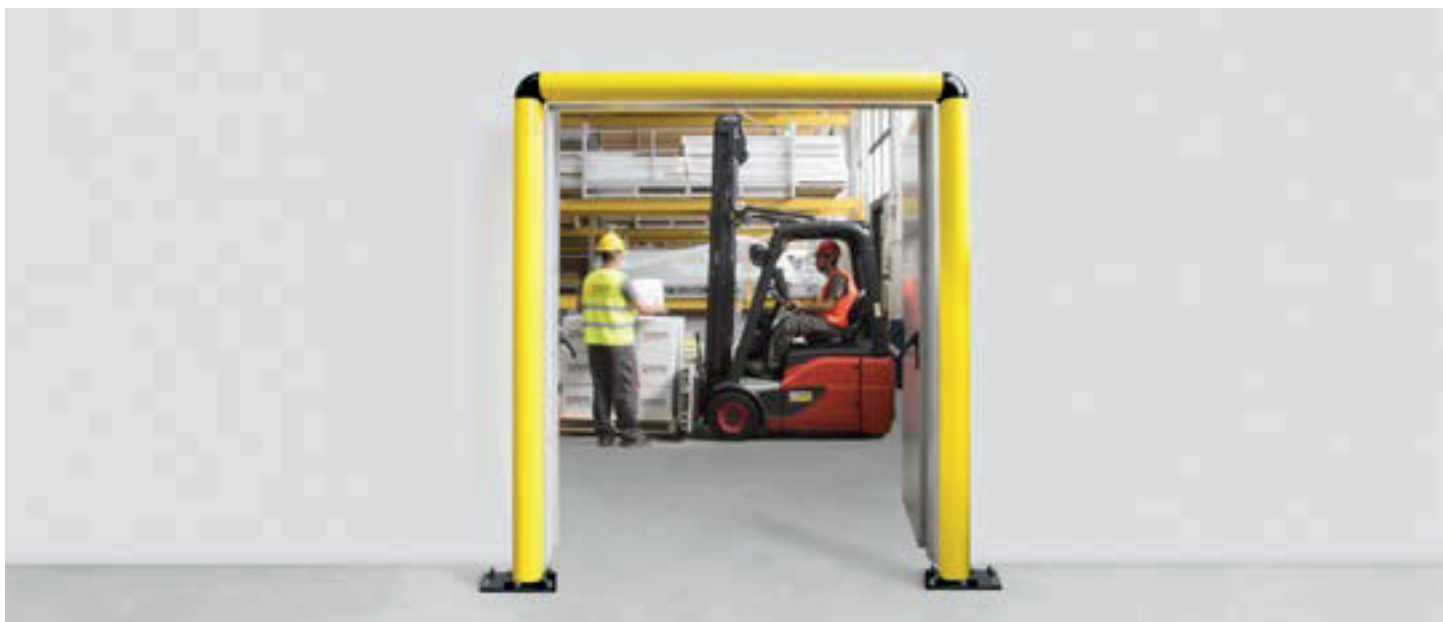

DOOR PEDESTRIAN 90

DIFFERENT SIZES ON REQUEST



MIN 600 MAX 1000



DP 90 ONE WAY

Packing Colour **to be defined**

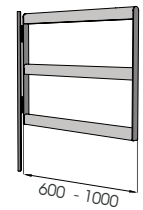

Equipped with accessories



DP 90 SWING

Packing Colour **to be defined**

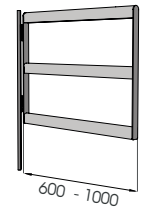

Equipped with accessories

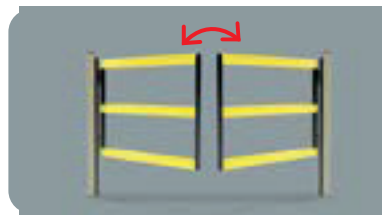

DP 90 SWING DOUBLE

Packing Colour **to be defined**

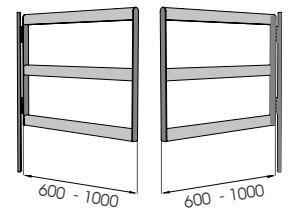

Equipped with accessories

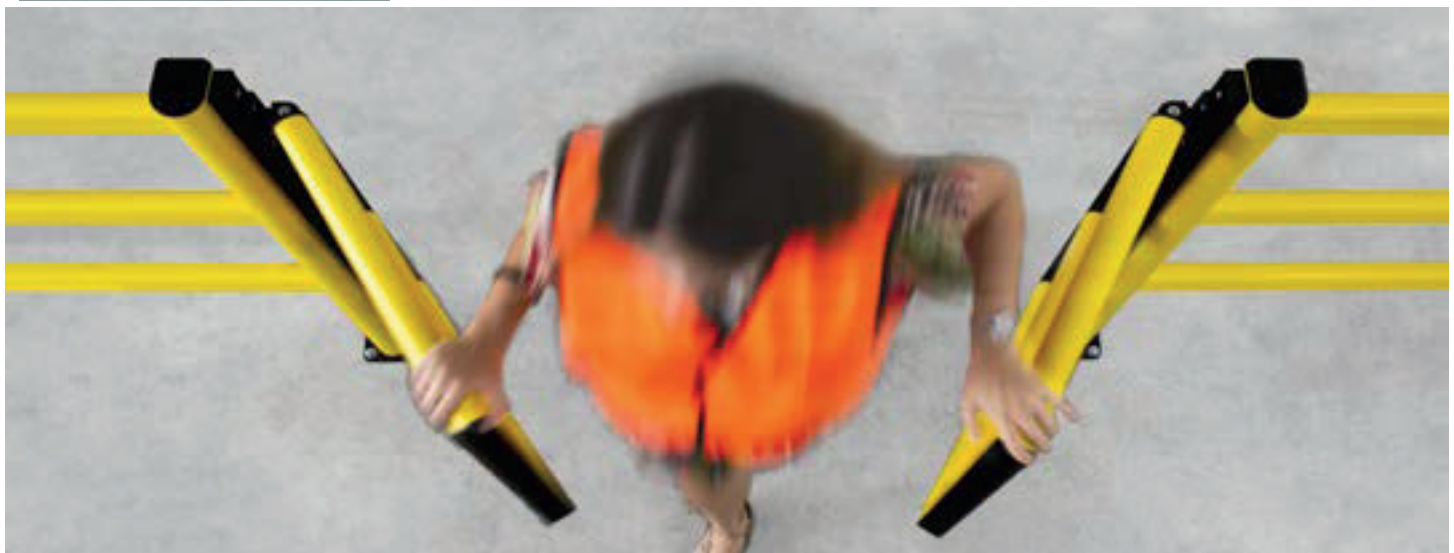

DOOR PEDESTRIAN 150

DIFFERENT SIZES ON REQUEST

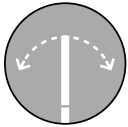

NEW SWING OPENING



MIN 600 MAX 1000

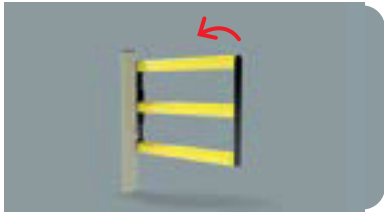

DP 150 ONE WAY

Packing Colour **to be defined**

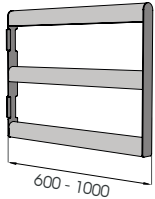

600 - 1000

Equipped with accessories

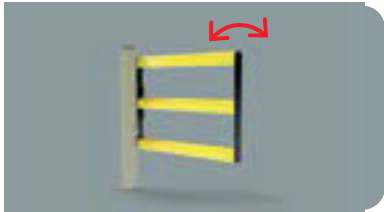

DP 150 SWING

Packing Colour **to be defined**

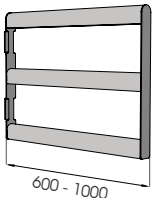

600 - 1000

Equipped with accessories

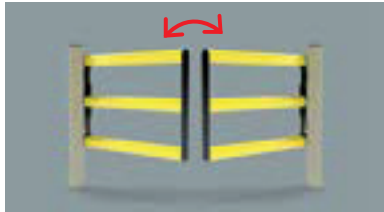

DP 150 SWING DOUBLE

Packing Colour **to be defined**

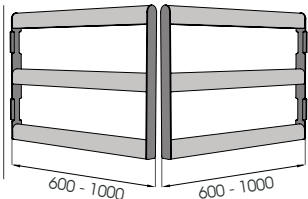

600 - 1000

600 - 1000

Equipped with accessories



Doors

LIFT GATE 90

DIFFERENT SIZES ON REQUEST

NEW

LIFT GATE 90 DOUBLE

x2
DOUBLE GATE

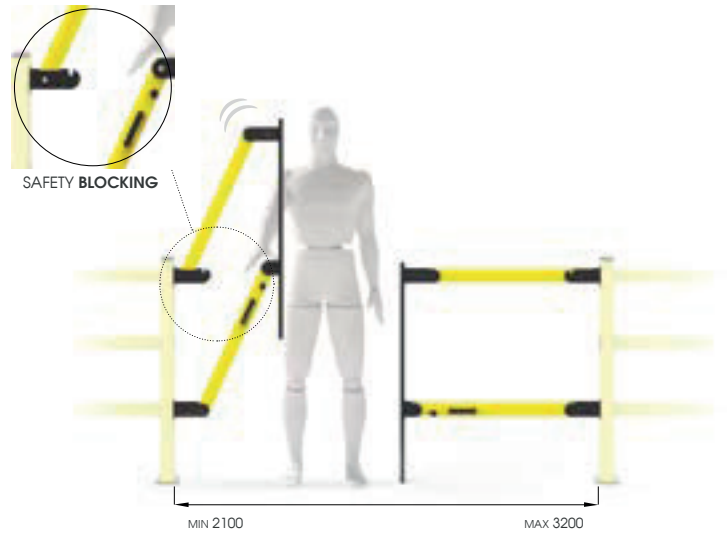
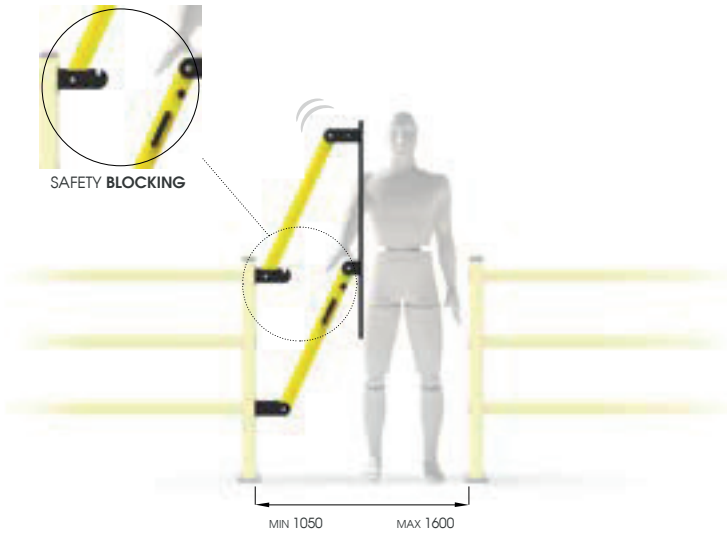

LIFT GATE 90

Packing Colour **to be defined**
 M



Equipped with accessories

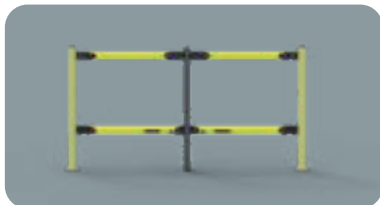

LIFT GATE 90 DOUBLE

Packing Colour **to be defined**
 M

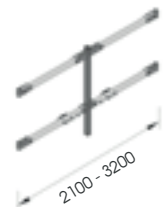

Equipped with accessories



LIFT GATE 150

DIFFERENT SIZES ON REQUEST

NEW

LIFT GATE 150 DOUBLE



DOUBLE GATE

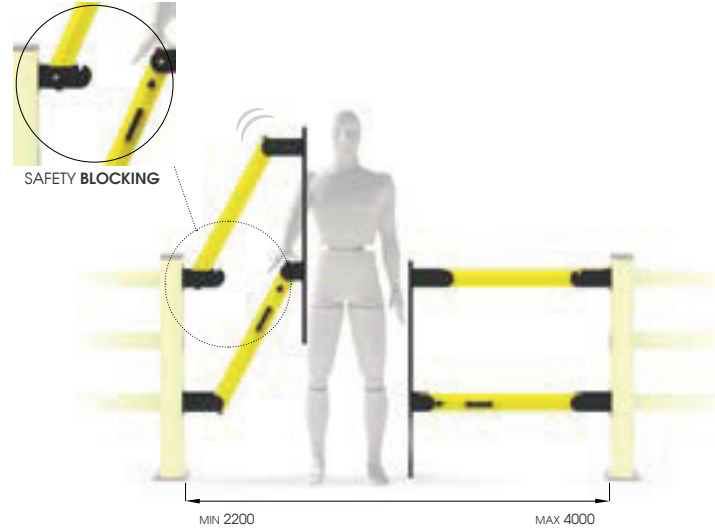
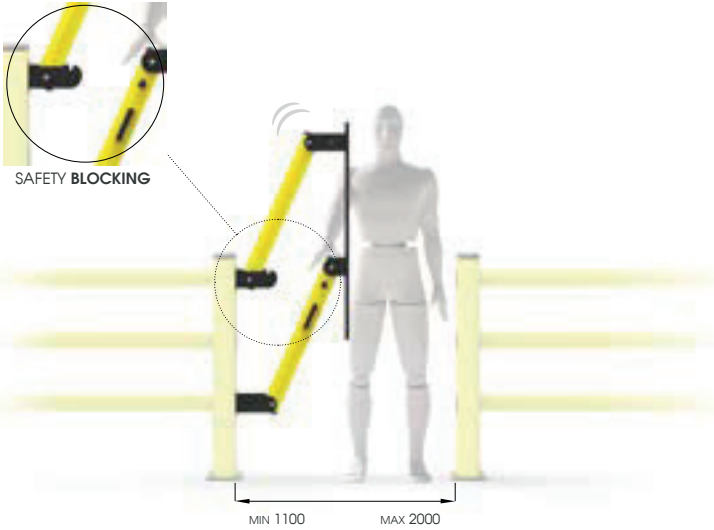

LIFT GATE 150

Packing Colour **to be defined**

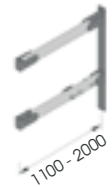

Equipped with accessories



LIFT GATE 150 DOUBLE

Packing Colour **to be defined**

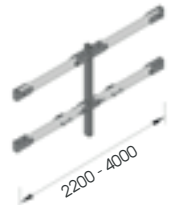

Equipped with accessories



07

LINK

The first adaptable barrier in the world thanks to the new connection system. Rail adjustable height, easy to set up, higher resistance in the most critical points.

Prima barriera al mondo regolabile a piacimento con nuovo sistema di raccordo. Altezza regolabile, facilmente componibili e resistenza potenziata nei punti più critici.

Première barrière au monde à modifier aux besoins avec un nouveau système de jonction. Hauteur à changer, facile à assembler et résistance renforcée aux points plus compliqués.

Primera barrera del mundo ajustable según lo necesario con un nuevo sistema de ajuste. Altura ajustable, fácilmente componibles y resistencia potenciada en los puntos más críticos.

**NEW
PRODUCT**



**ADAPTABLE
HEIGHT**



**ON YOUR
NEEDS**

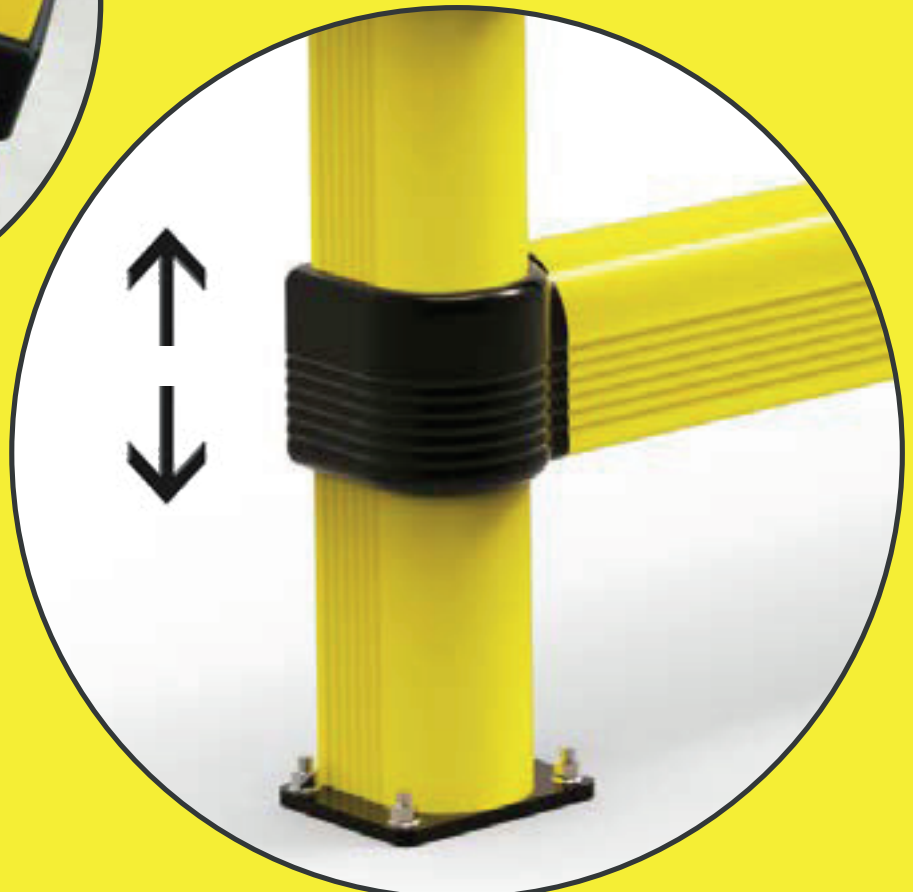

LINK 150/3



DIFFERENT SIZES ON REQUEST

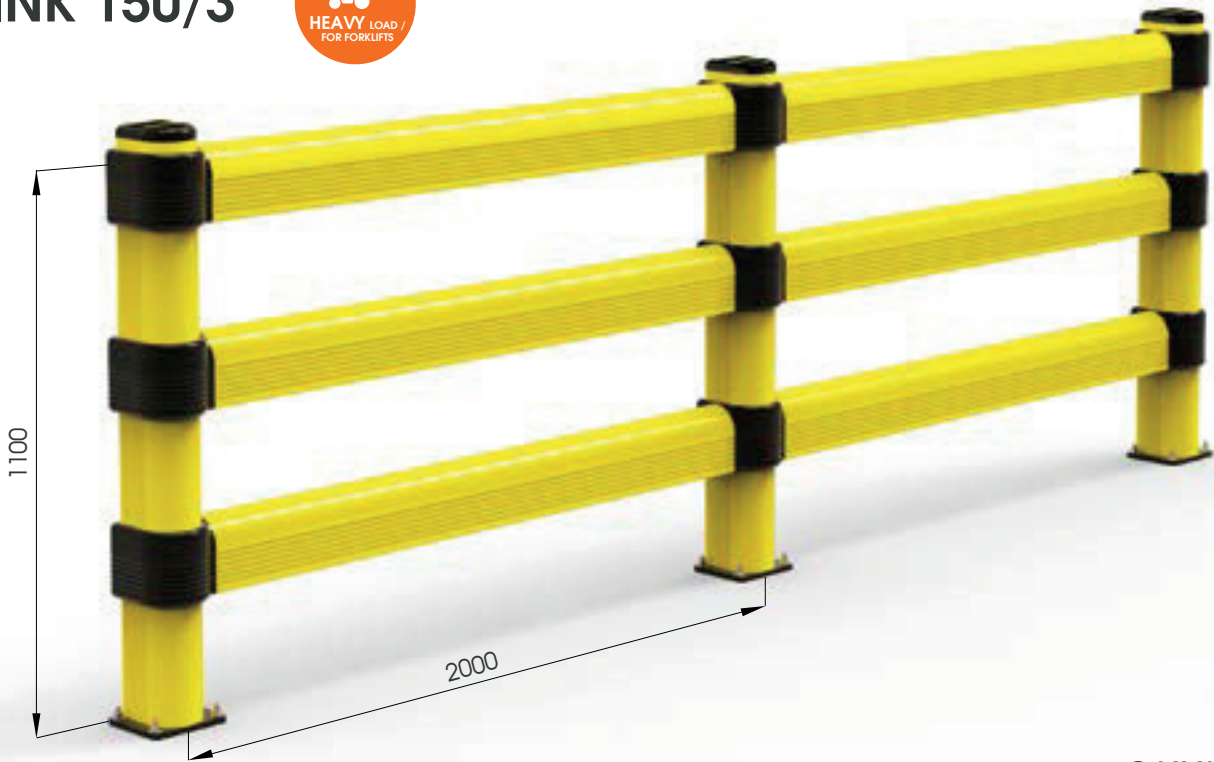

M12 GALVANISED STEEL

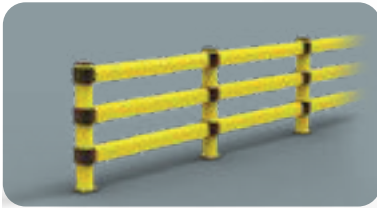

LINK 150/3

Packing **unpacked on pallet**
Colour **M**

Equipped with accessories

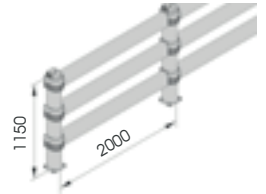

LINK 150/3 CORNER

Packing **unpacked on pallet**
Colour **M**

Equipped with accessories



Link

LINK 150/2



DIFFERENT SIZES ON REQUEST

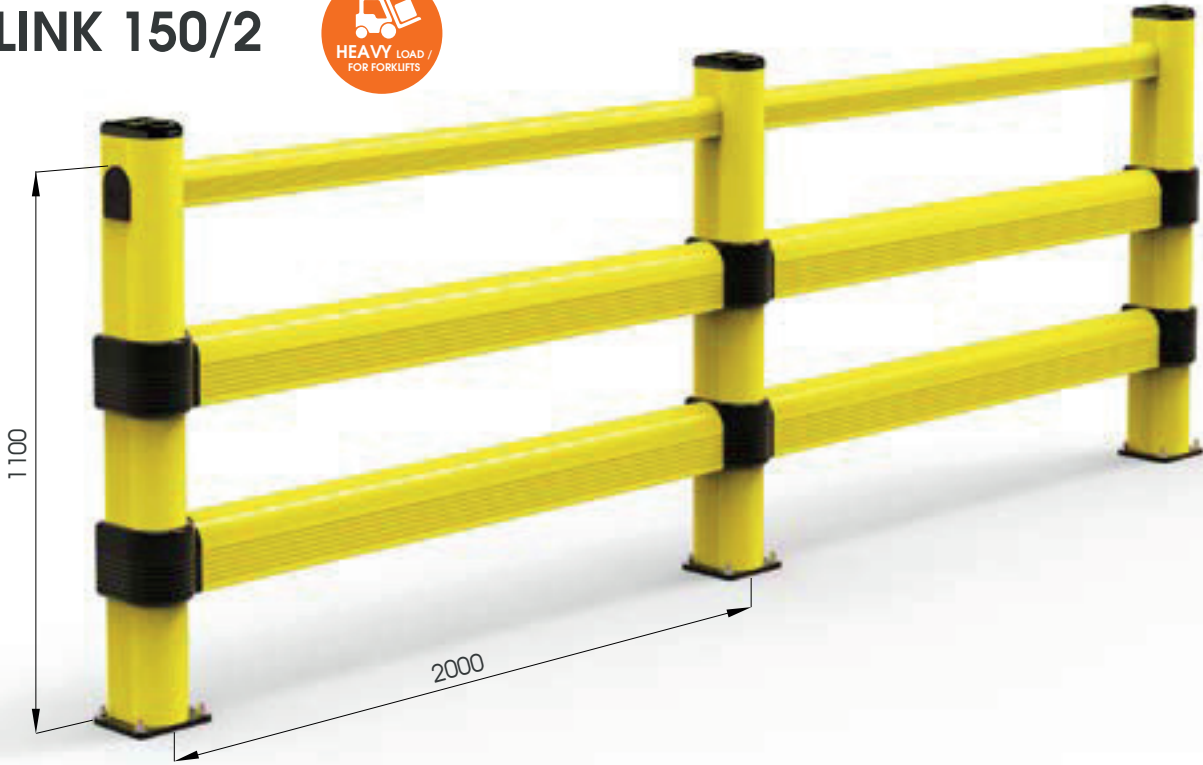

M12 GALVANISED STEEL

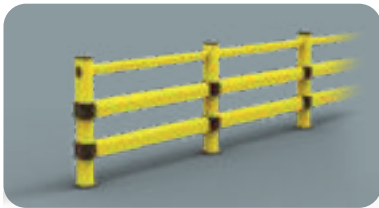

LINK 150/2

Packing Colour **unpacked on pallet**

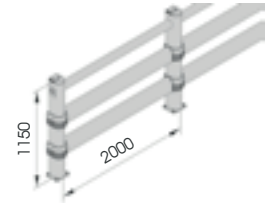

Equipped with accessories

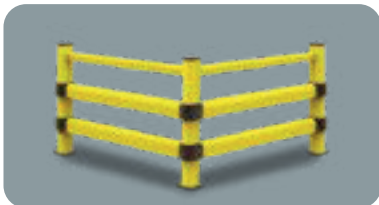

LINK 150/2 CORNER

Packing Colour **unpacked on pallet**

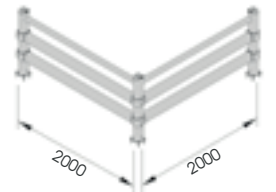

Equipped with accessories



LINK 150/1



DIFFERENT SIZES ON REQUEST



M12 GALVANISED STEEL

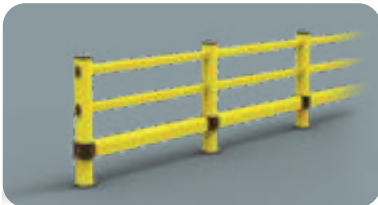

LINK 150/1

Packing **unpacked on pallet**
Colour

Equipped with accessories

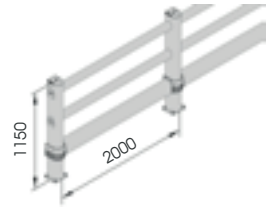

LINK 150/1 CORNER

Packing **unpacked on pallet**
Colour

Equipped with accessories

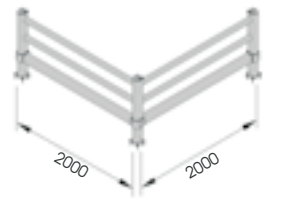

Link

LINK LM



DIFFERENT SIZES ON REQUEST

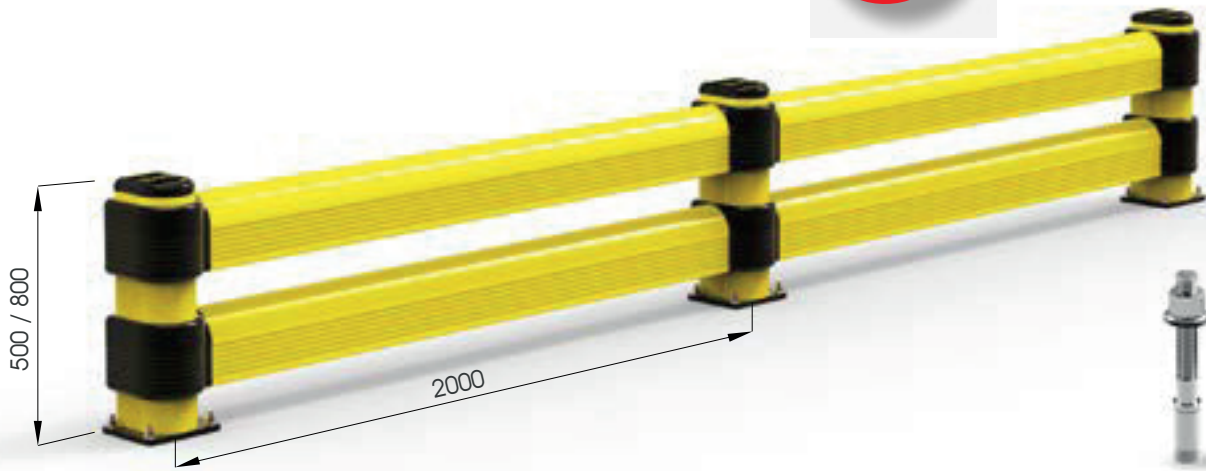

M12 GALVANISED STEEL

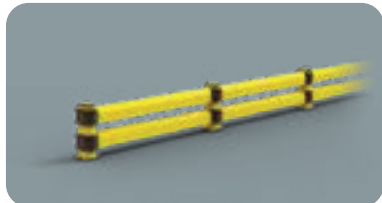

LINK LM 500 800

Packing Colour **unpacked on pallet** M

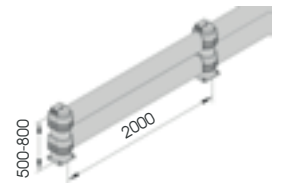

Equipped with accessories



LINK LM CORNER

Packing Colour **unpacked on pallet** M

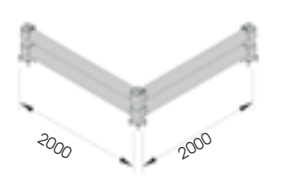

Equipped with accessories



LINK SINGLE



DIFFERENT SIZES ON REQUEST

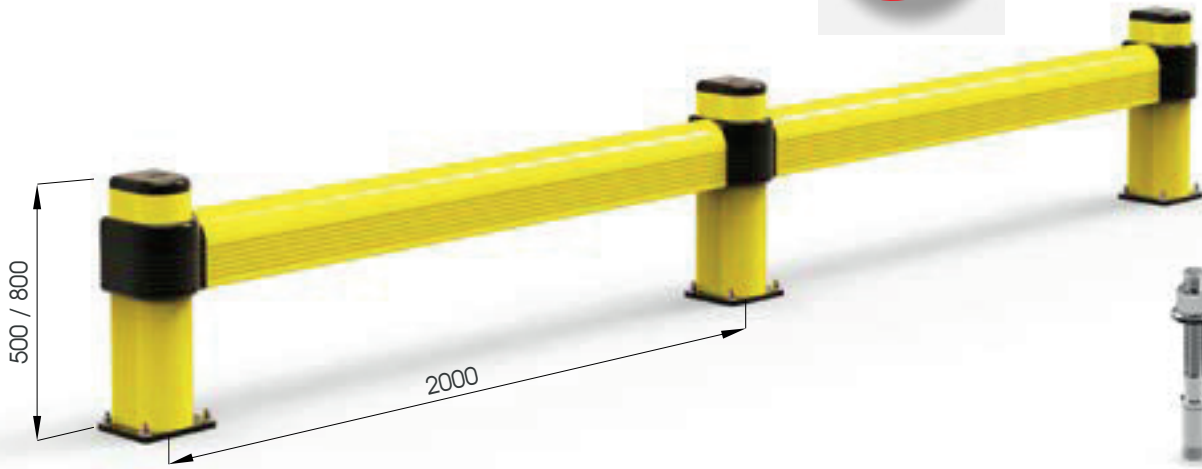

M12 GALVANISED STEEL

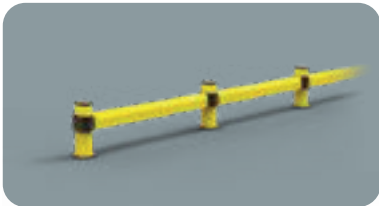

LINK SINGLE 500 800

Packing Colour **unpacked on pallet** M

Equipped with accessories

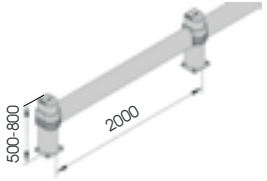

LINK SINGLE CORNER

Packing Colour **unpacked on pallet** M

Equipped with accessories



08

B FLEX

A new safety protection system with reinforced profile. It is a more flexible and shock-absorber solution. Designed to ensure high safety standards and to resist impacts from heavy loads. Available in many different versions.



Nuovo sistema di protezioni con profilo rinforzato, doppiamente flessibile e assorbente. Progettato e realizzato con un particolare design per garantire alti livelli di sicurezza e resistere all'„impatto da carichi pesanti. Disponibile in diverse versioni.

Nouveau système de protection avec profil renforcé, doublement flexible et absorbant. Conçu et produit avec un design particulier pour assurer des niveaux élevés de sécurité et résister à l'„impact des charges lourdes. Disponible en plusieurs versions.

Nuevo sistema de protección con perfil reforzado, más flexible y capaz de absorber los impactos. Diseñado para asegurar el entorno laboral y para resistir a los impactos de cargas pesadas. Disponible en diferentes versiones.

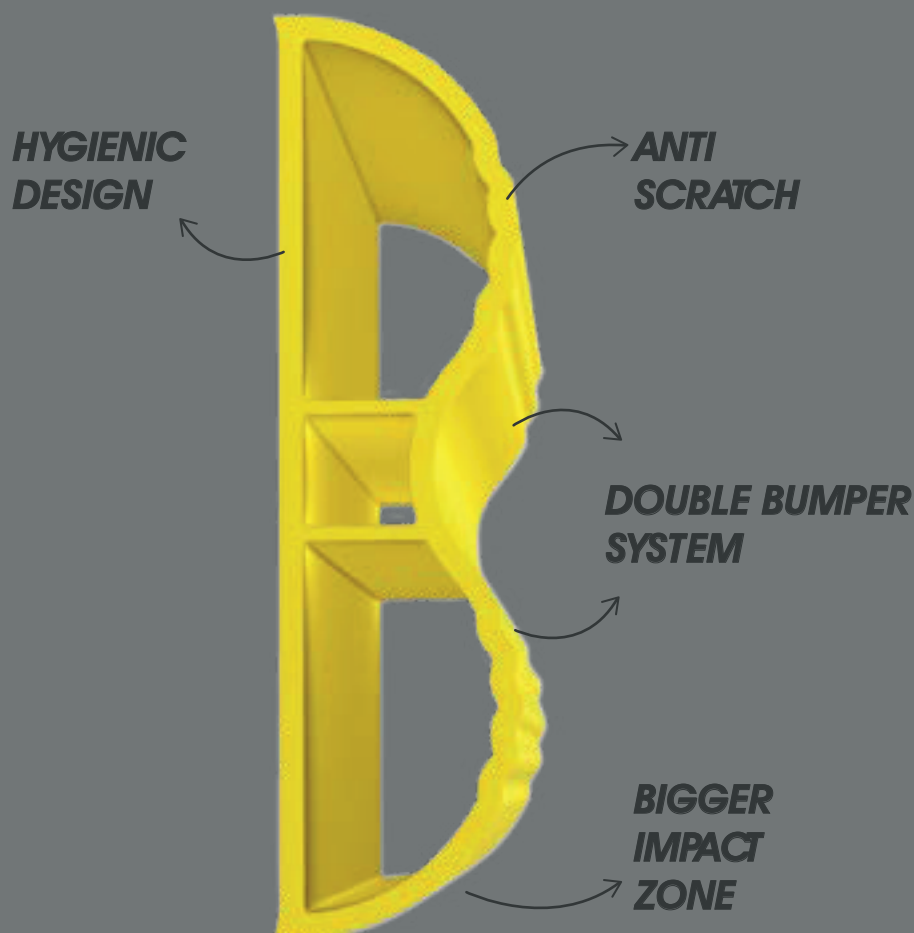

BFLEX.FRONT/1



INCLUDED

M12
GALVANISED STEEL



**BFLEX.FRONT/1 2000x450
MODULAR**

Packing Colour **unpacked on pallet**
Colour **M**

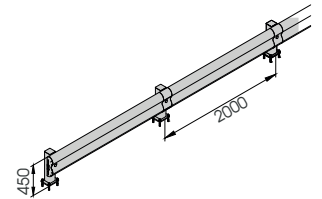

Equipped with accessories



**BFLEX.FRONT/1 1100x450
BFLEX.FRONT/1 2400x450**

Length **1.100 / 2.400 mm**
Packing Colour **unpacked on pallet**
Colour **M**

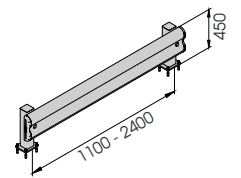

Equipped with accessories



BFLEX.FRONT/2



BFLEX.FRONT/2 2000x1100 MODULAR

Packing Colour **unpacked on pallet**
M

Equipped with accessories

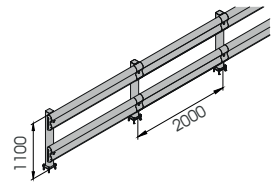

BFLEX.FRONT/2 1100x1100
BFLEX.FRONT/2 2400x1100

Length Packing Colour **1.100 / 2.400 mm**
unpacked on pallet
M

Equipped with accessories

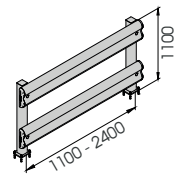

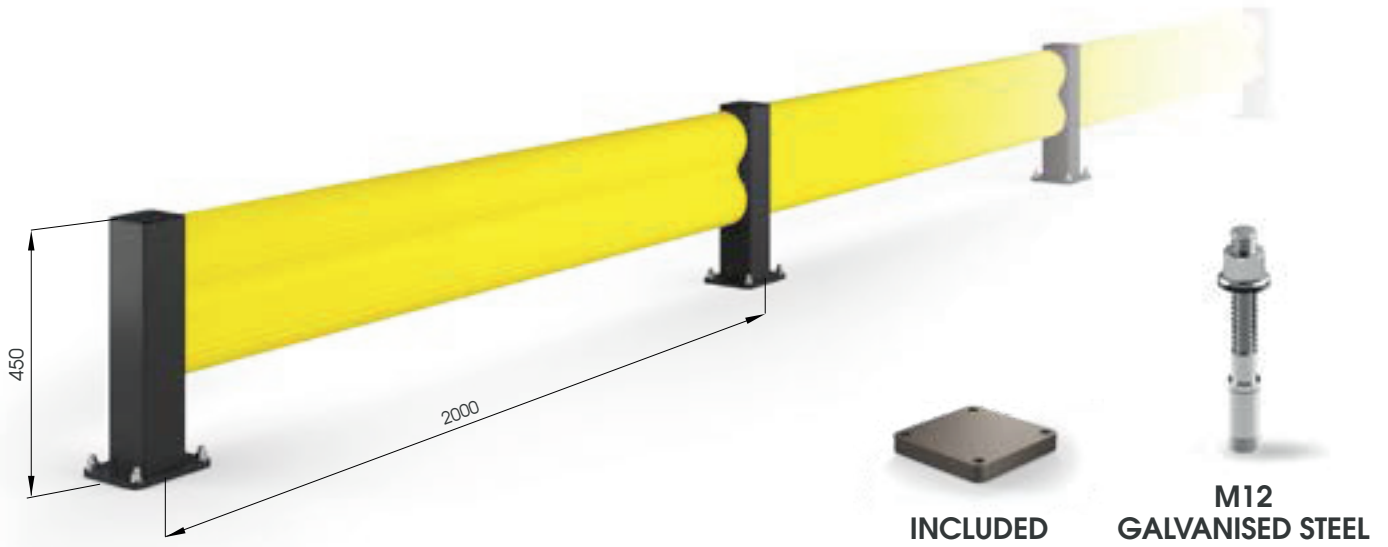

**BFLEX.COM/1 2000x450
MODULAR**

Packing Colour **unpacked on pallet**
 B M

Equipped with accessories

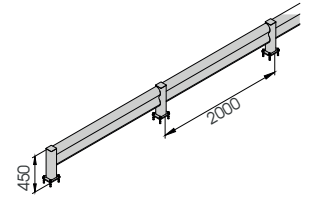

**BFLEX.COM/1 1100x450
BFLEX.COM/1 2400x450**

Length Packing Colour **unpacked on pallet**
 B M

Equipped with accessories

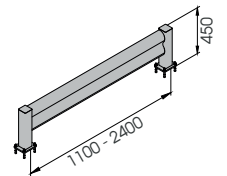

BFLEX.COM/2

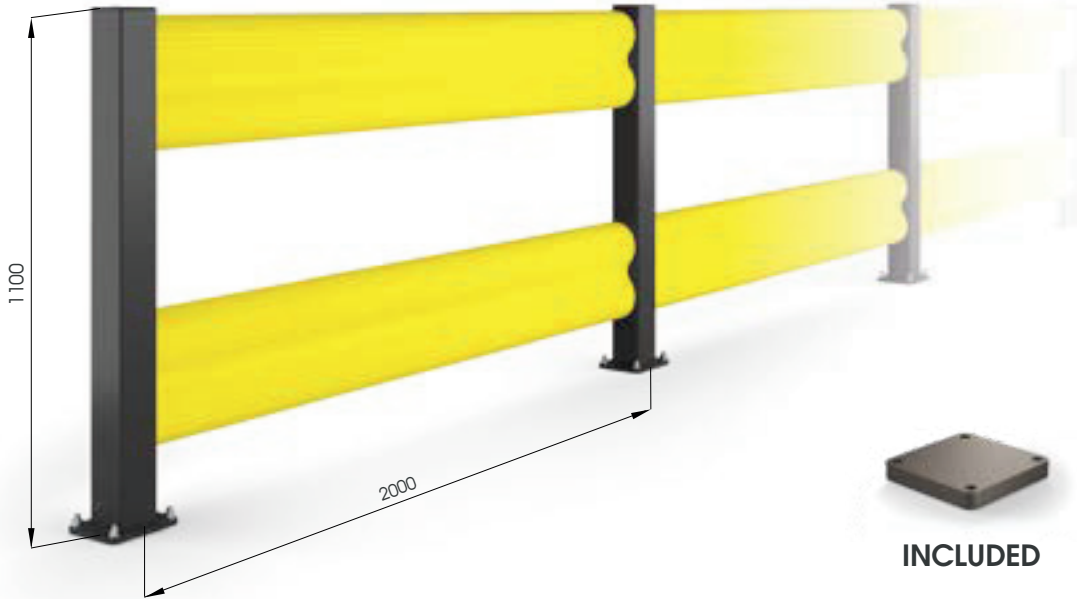

INCLUDED



M12 GALVANISED STEEL



BFLEX.COM/2 2000x1100 MODULAR

Packing Colour **unpacked on pallet**
B M

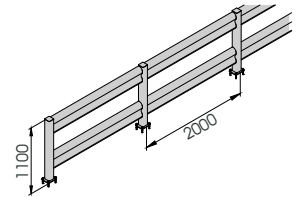

Equipped with accessories



BFLEX.COM/2 1100x1100
BFLEX.COM/2 2400x1100

Length Packing Colour **1.100 / 2.400 mm**
unpacked on pallet
B M

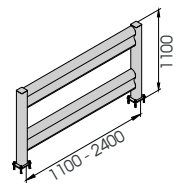

Equipped with accessories



REMOVABLE PLATE

NOW READY
NEW OPTIONS FOR
OUR **SAFETY BARRIERS**
AND **RACK PROTECTORS**



REMOVABLE PLATE

AVAILABLE FOR:
LINK / SM / LM / FENCE
HR 90 / PED 90 / PED 150



09

COLUMN PROTECTION

A new bumper system specific for the protection of the columns resistant against trolleys movements and for different load types. Designed by following an innovative technical design that combines speed and simplicity in the steps of installation and cleaning. Available in different heights and fixing systems.



Sistema di profili specifico per la protezione delle colonne dai carrelli in movimento di varie portate. Progettato seguendo un innovativo disegno tecnico che coniuga rapidità e semplicità nella fasi di installazione e pulizia. Disponibile in diverse altezze e tipologie di fissaggio.

Nouveau système bumper, spécifique pour protéger les poutres contre les mouvements des chariots. Étudié avec un modern dessin qui regroupe la rapidité et la facilité pendant l'installation et le nettoyage. Disponible en différents hauteurs et différents fixations.

Sistema de perfiles específico para la protección de las columnas de los carros en movimiento de diferentes capacidades. Diseñado según un innovador diseño técnico que une velocidad y simplicidad en las fases de instalación y limpieza. Disponible en diferentes alturas y tipos de fijación.

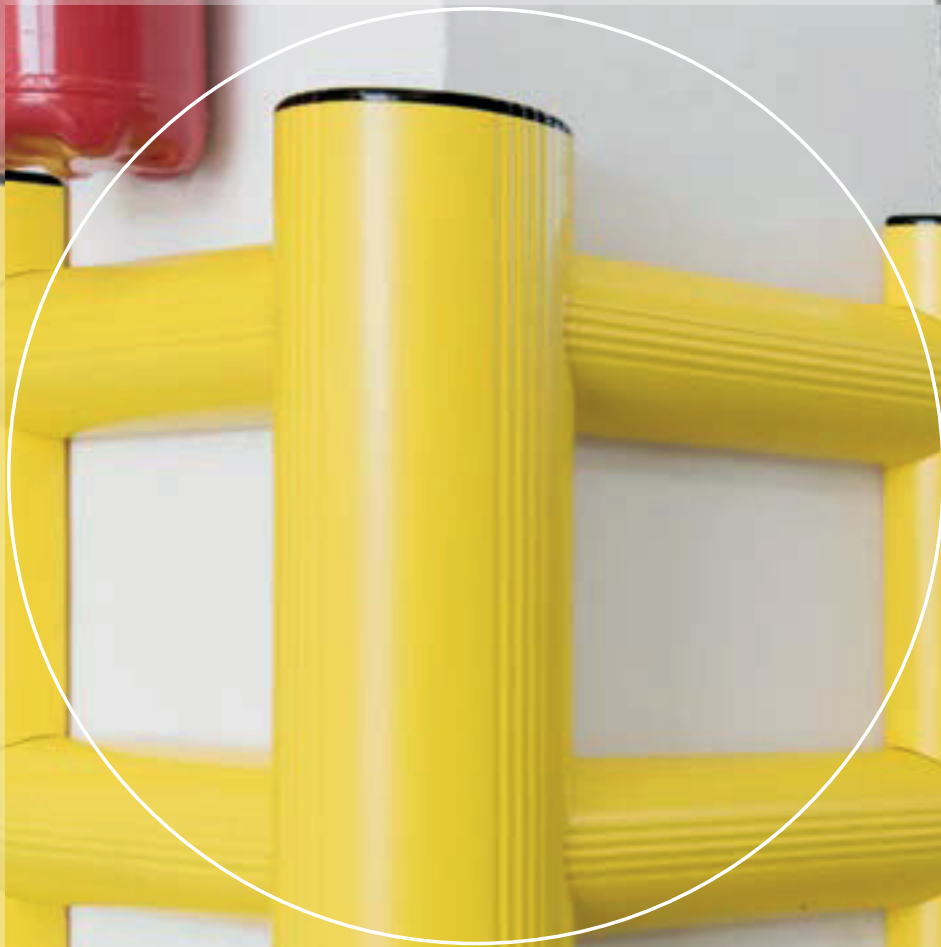

- REMOVABLE
- NO SCRATCHES
- VERY SOLID AND SLIM DESIGN
- NO FIXING IS REQUIRED

Column protection

COLUMN PROTECTION 90



DIFFERENT SIZES ON REQUEST

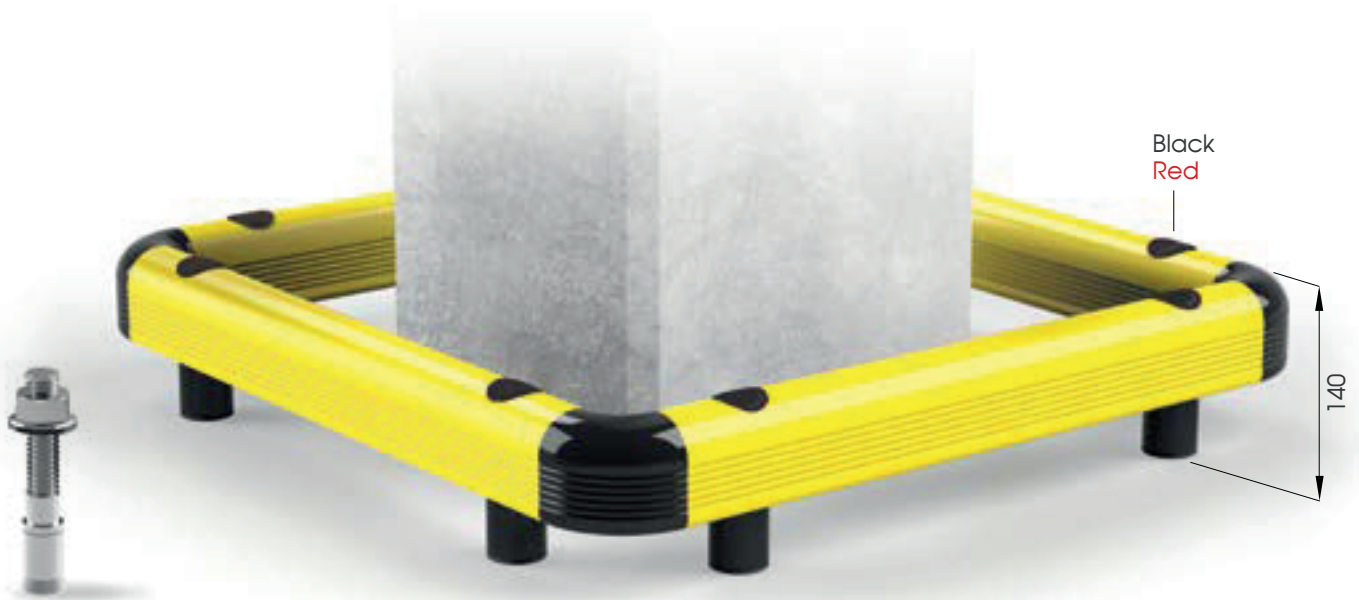

M16
STAINLESS STEEL



COPRO 90 500x500
600x600
700x700

Equipped with accessories

Packing Colour **unpacked on pallet**

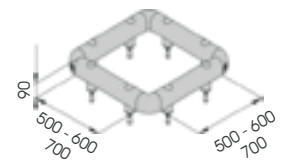

COLUMN PROTECTION 150

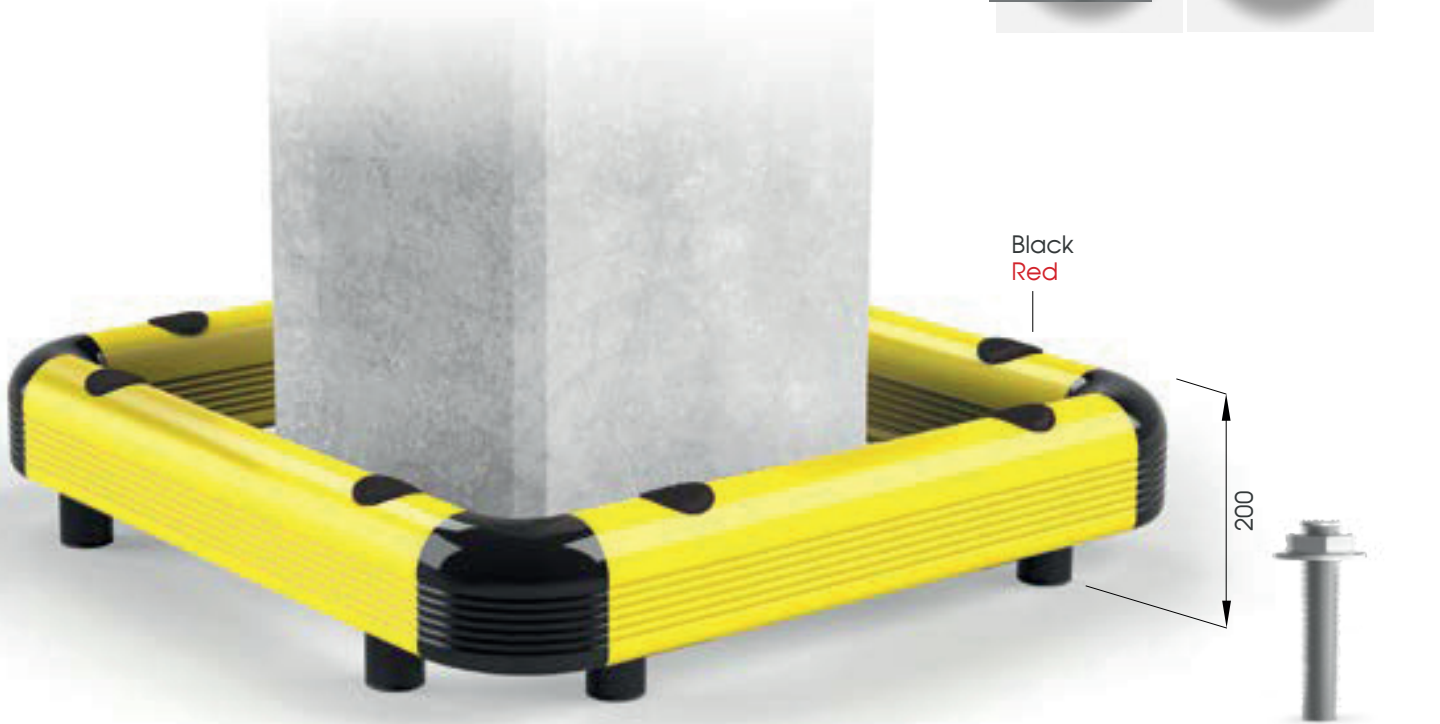

COPRO 150 500x500
600x600
700x700

Equipped with accessories

Packing: unpacked on pallet
Colour: M

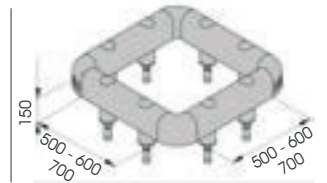

Column protection

HUG TOWER



CHOOSE THE HEIGHT YOU NEED, UP TO 5 RAILS

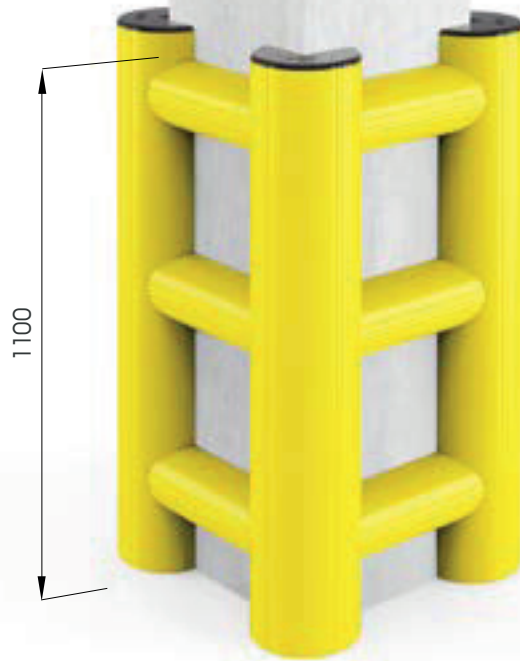
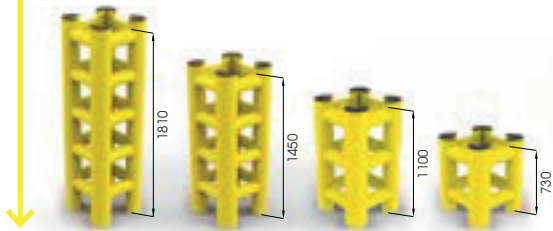

DIFFERENT SIZED AND HEIGHT ON REQUEST

COMPACT



NO HOLES ON THE FLOOR AND COLUMN



HUG TOWER 500x500
600x600
700x700

Packing Colour **to be defined**
M

Equipped with accessories

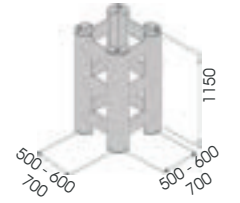

HUG TOWER 3 SIDES

Packing Colour **to be defined**
M

Equipped with accessories



TOWER PROTECTION

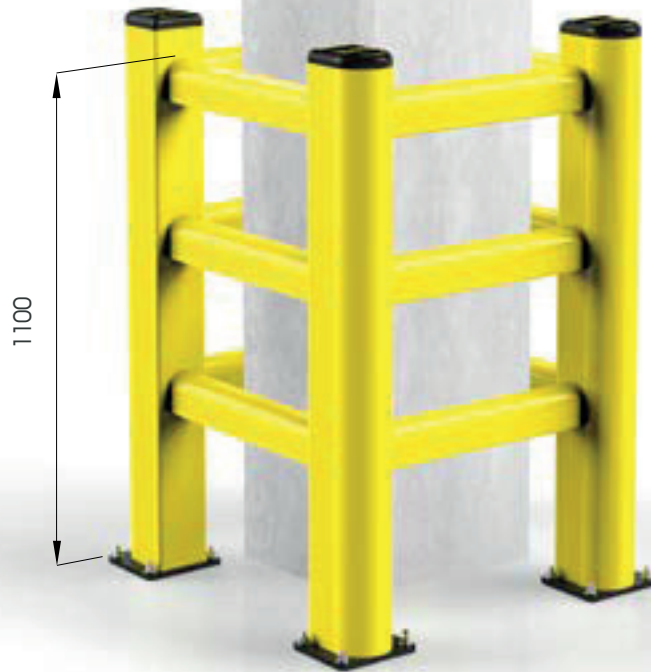

**M12
GALVANISED STEEL**



**TOWER 500x500
600x600
700x700**

Equipped with accessories

Packing Colour **to be defined**

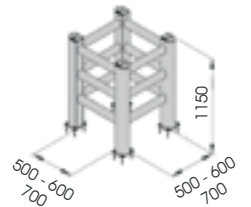

10

LOADING BAYS PROTECTIONS

Loading bays protections are shock-proof solutions which are set up near loading doors. They avoid possible slipping, falling and tipping of moving vehicles near open and unmanned loading bays.

Sistema di protezione antiurto installato in prossimità delle porte di carico. Permettono di evitare situazioni ad alto rischio di scivolamento, caduta e ribaltamento dei mezzi in movimento in presenza di baie di carico aperte e non presidiate.

Système de protection contre les chocs installé près des portes de chargement. Ils permettent d'éviter des situations en raison du risque élevé de glissement, de chute et de basculement des véhicules en mouvement en présence de quais de chargement ouverts et sans surveillance.

La protección de muelles de carga es un sistema anticolidión que está cerca de las puertas de carga. Evitan los riesgos de deslizamiento, caída y derrocamiento los vehículos en movimiento cuando están cerca de los muelles de carga abiertos y no vigilados.



DOCK GATE

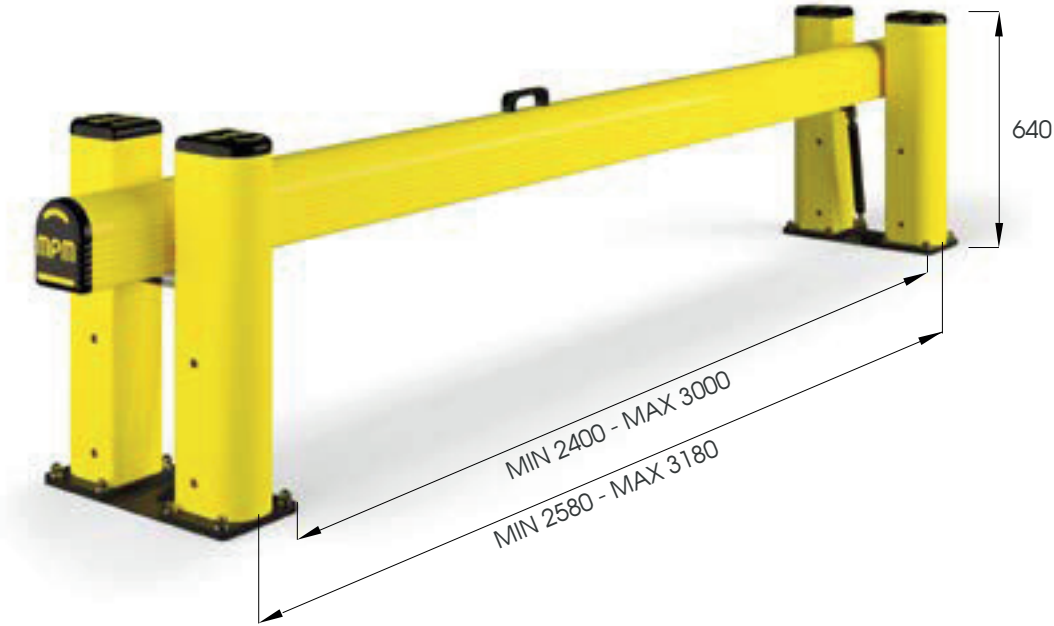

**M12
GALVANISED STEEL**



DOCK GATE L **2400-2500**

Packing Colour **to be defined**

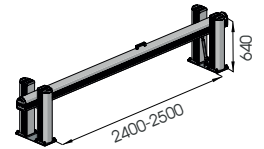

Equipped with accessories



DOCK GATE XL **2500-3000**

Packing Colour **to be defined**

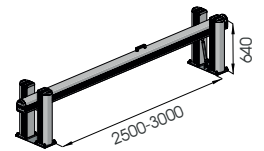

Equipped with accessories



11

CORNER PROTECTION

Designed to protect pillars and columns or external corners of walls and panels.

Realizzato per proteggere pilastri e colonne o angoli esterni di muri e pannelli.

Étudié pour protéger les poteaux et les colonnes ou les angles extérieurs de murs et de panneaux.

Realizado para proteger pilares y columnas o esquinas exteriores de paredes y paneles.



**E' VIETATO
FUMARE E USARE
FIAMME LIBERE**

Corner Protection

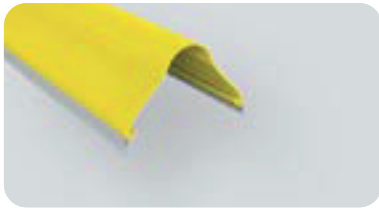

CP 100

Length **4.000 mm**
 Packing **10 pz / box**
 Colour **B M E F**

Length **2.000 mm**
 Packing **10 pz / bag**
 Colour **M**

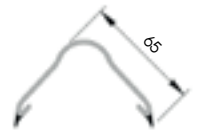

CPF 100

Length **4.000 mm**
 Packing **10 pz / bag**

Length **2.000 mm**
 Packing **10 pz / bag**



CPT 100

Packing **40 pz / box**
 Colour **B E F**

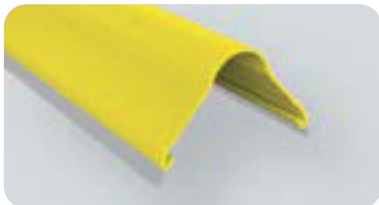
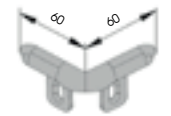

CP 200

Length **4.000 mm**
 Packing **2 pz / bag**
 Colour **B M E**

Length **2.000 mm**
 Packing **2 pz / bag**
 Colour **M**

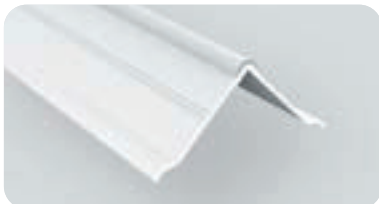

CPF 200

Length **2.000 / 4.000 mm**
 Packing **2 pz / bag**



CPT 200

Packing **20 pz box**
 Colour **B E**

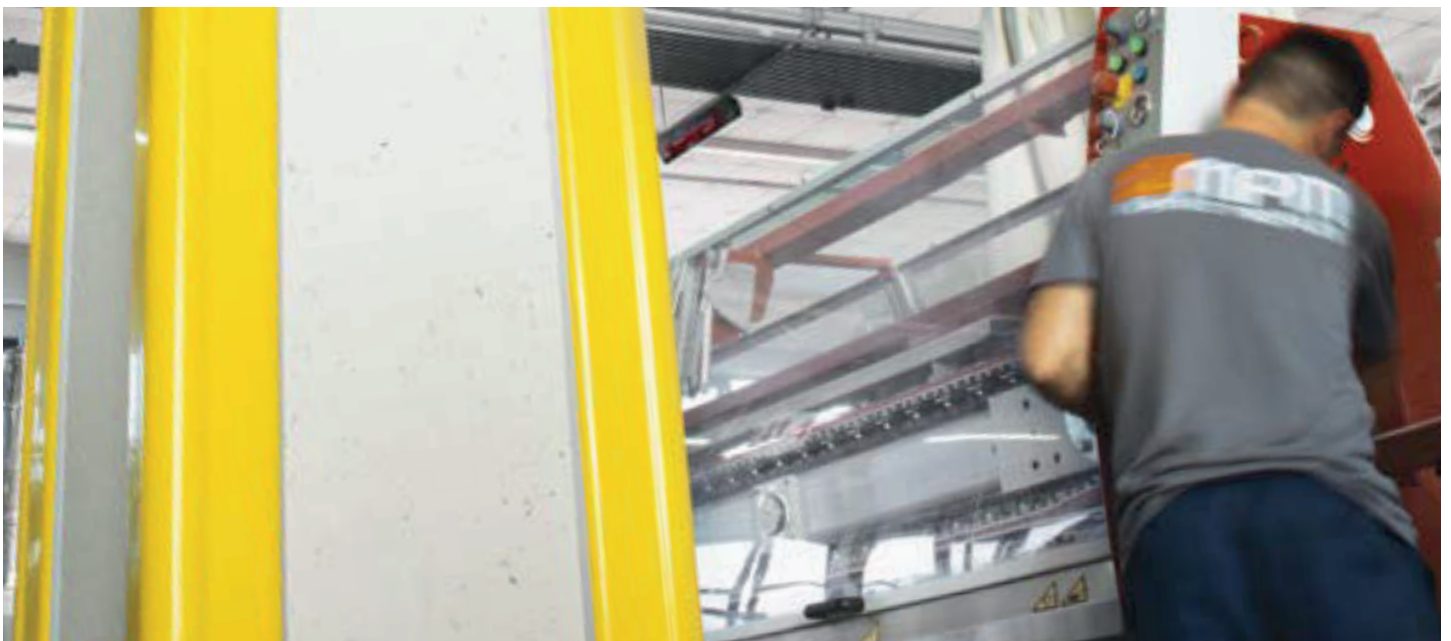
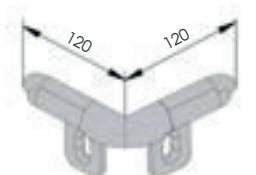

12

KERB

A large size protection system, ideal for walls and panels. Easy to install and clean. Fully equipped with corner caps and buttons.



Sistema di protezione di grandi dimensioni,
ideale per muri e pannelli. Facile da installare e pulire
Completo di angolari e tappi.

Système de protection
de grands dimensions, idéal
pour les murs et les panneaux.
Facile à installer et à nettoyer.
Complété de bouchons
d'angles et d'embouts.

Sistema de protección
de grande dimensión,
ideal para paredes
y paneles. Fácil de instalar
y limpiar. Completo de
esquinas y tapas.

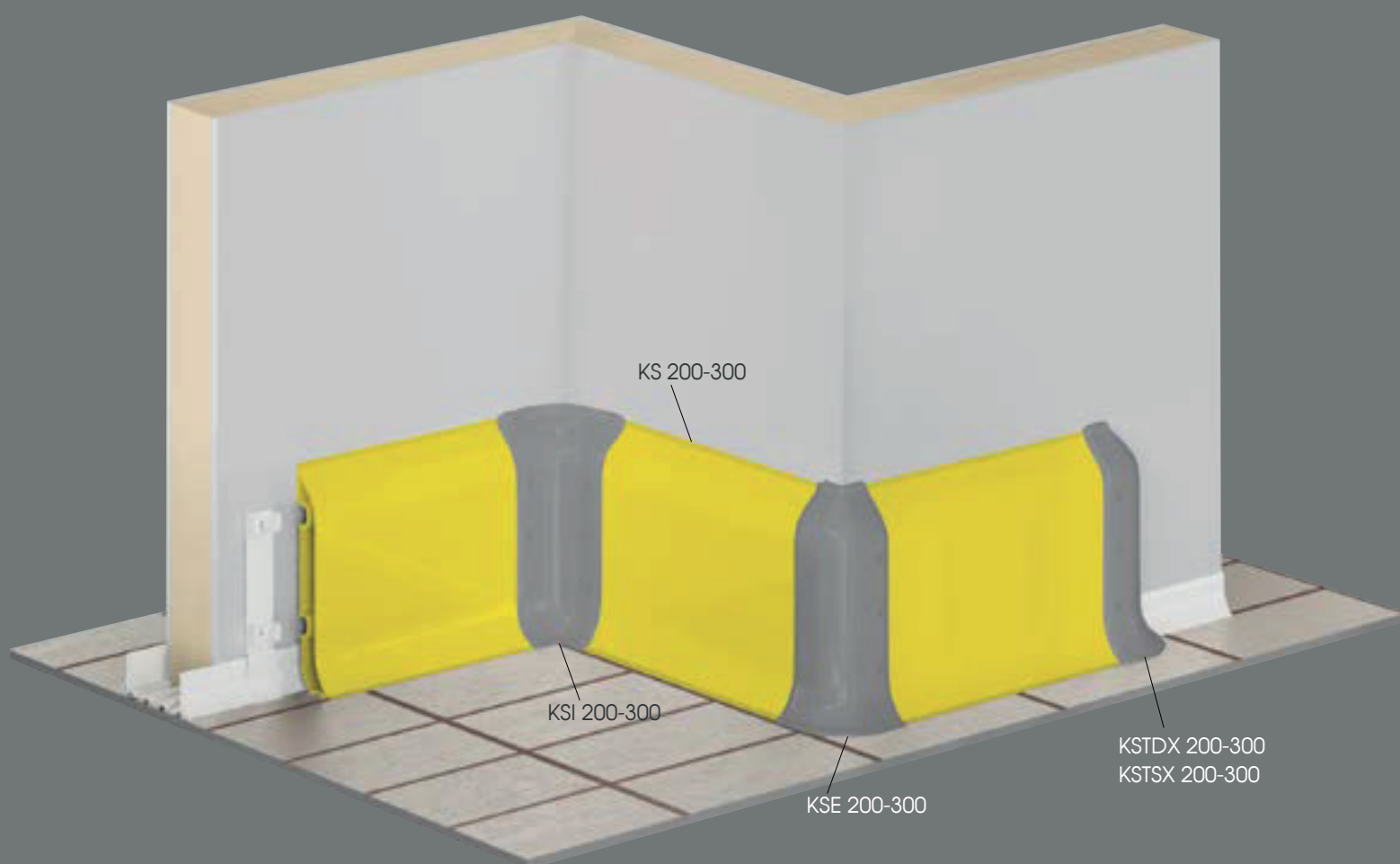

Kerb



KS 200

Length **4.000 mm**
 Packing **3 pz / box**
 Colour **B** **M** **E**

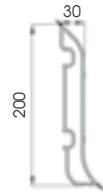

KEPF 200

To install with TB14

Packing **50 pz / box**
 Colour **K**

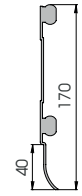

KSJ 200

To install with TB14 / TF14

Packing **20 pz / box**
 Colour **B** **E**

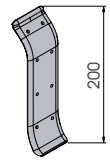

KSI 200

To install with TB14 / TF14

Packing **20 pz / box**
 Colour **B** **E**

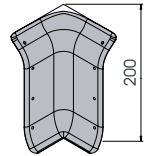

KSE 200

To install with TB14 / TF14

Packing **20 pz / box**
 Colour **B** **E**

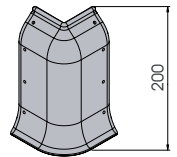

KSTD/SX 200

To install with TB14 / TF14

Packing **20 pz / box**
 Colour **B** **E**

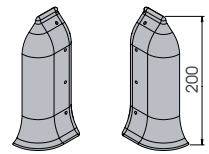

KSJ 200 LT



Packing **to be defined**
 Colour **K**

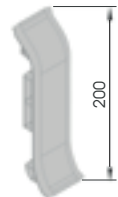

KS 300

Length **4.000 mm**
 Packing **1 pz**
 Colour **M** **E**

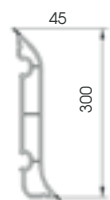

KEPF 300

To install with TB20

Packing **40 pz / box**

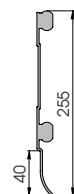



KSJ 300
To install with TB20 / TF20

Packing 10 pz / box
Colour B E

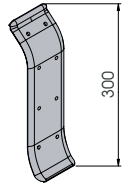

KSI 300
To install with TB20 / TF20

Packing 10 pz / box
Colour B E

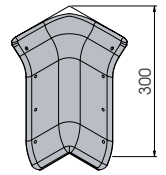

KSE 300
To install with TB20 / TF20

Packing 10 pz / box
Colour B E

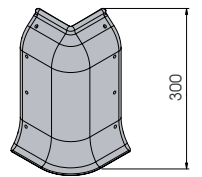

KSTD/SX 300
To install with TB20 / TF20

Packing 10 pz / box
Colour B E

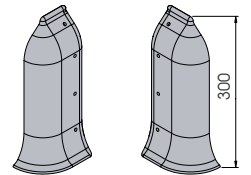

13

WALL PROTECTION

New bumper without guides. Thanks to its big size and resistance it is ideal for protection of industrial spaces. Fixed caps with hidden screws covered by specific buttons.

Nuovo profilo antiurto senza guida. La sua ampiezza e resistenza lo rende ideale per la protezione di ambienti industriali. Terminali fissati con viti nascoste da appositi bottoni.

Nouveau profilé anti-choc sans besoin d'une base à fixer. Sa mesure large et sa résistance en font le profilé parfait pour la protection des espaces industriels. Embouts fixés avec des vis cachées grâce à des bouchons spécifiques.

Nuevo perfil antigolpe sin guía. Su amplitud y resistencia lo hacen ideal para la protección de entornos industriales. Terminales fijados con tornillos ocultos por botones especiales.



Wall Protection

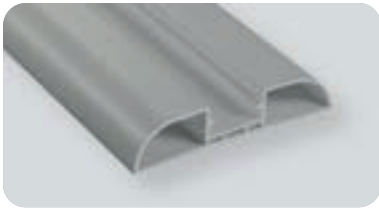
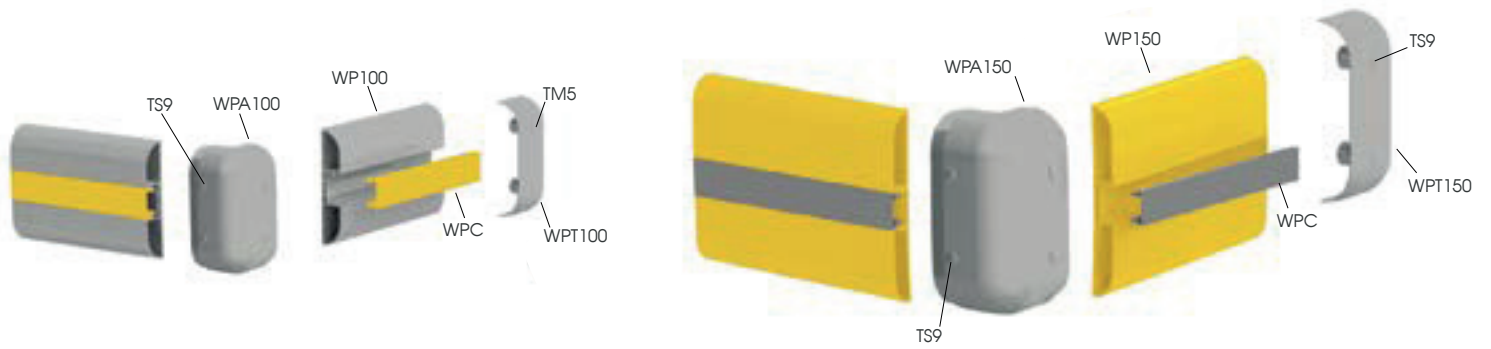

WP 100

Length **4.000 mm**
 Packing **8 pz / box**
 Colour **B E F**

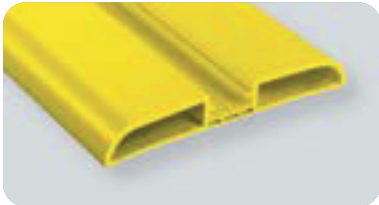
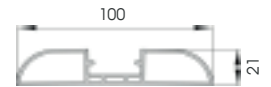

WP 150

Length **4.000 mm**
 Packing **4 pz / box**
 Colour **B M E**

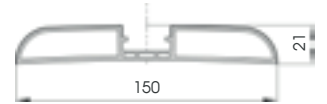

WPC

To install with WP 100 / WP 150

Length **4.000 mm**
 Packing **16 pz / box**
 Colour **A B M D E F G H**

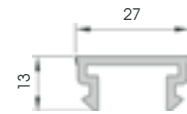

WPT 100

To install with TM5

Packing **50 pz / box**
 Colour **B E F**

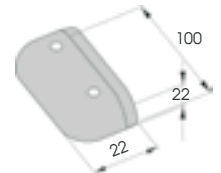

WPA 100

To install with TS9

Packing **20 pz / box**
 Colour **B E**

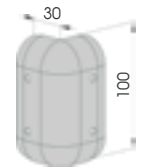

WPT 150

To install with TM5

Packing **50 pz / box**
 Colour **B E**

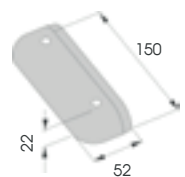

WPA 150

To install with TS9

Packing **20 pz / box**
 Colour **B E**

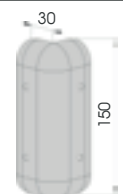

Wall Protection

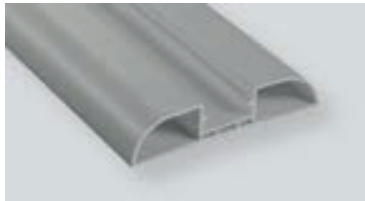
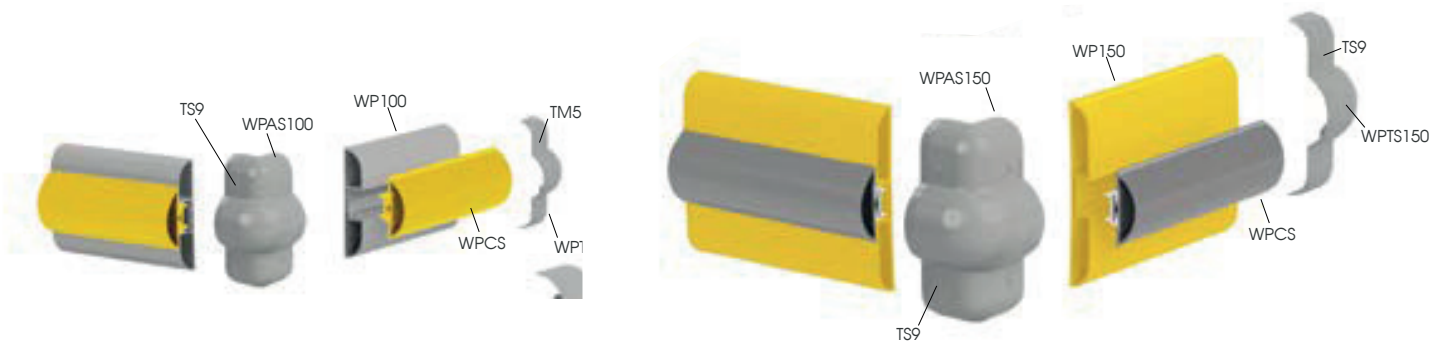

WP 100

Length **4.000 mm**
Packing **8 pz / box**
Colour **B E F**

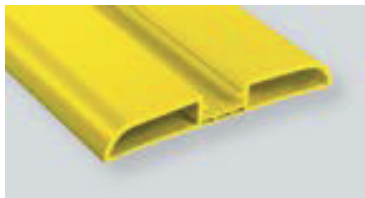
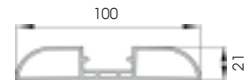

WP 150

Length **4.000 mm**
Packing **4 pz / box**
Colour **B M E**

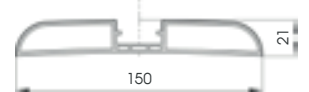

WPCS

To install with WP 100 / WP 150

Length **4.000 mm**
Packing **8 pz / box**
Colour **A B M D E F G H I**

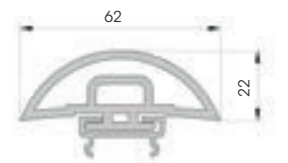

WPTS 100

To install with TS9

Packing **20 pz / box**
Colour **B E**

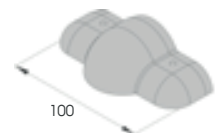

WPAS 100

To install with TS9

Packing **20 pz / box**
Colour **B E**

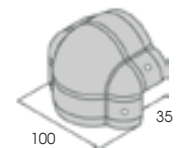

WPTS 150

To install with TS9

Packing **20 pz / box**
Colour **B E**

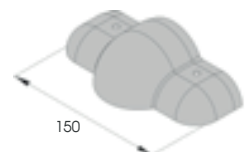

WPAS 150

To install with TS9

Packing **20 pz / box**
Colour **B E**

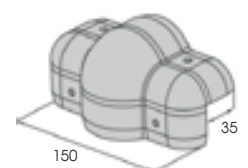

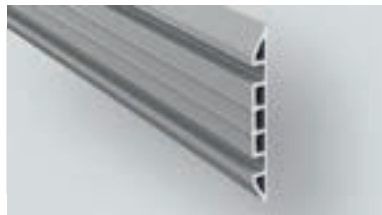
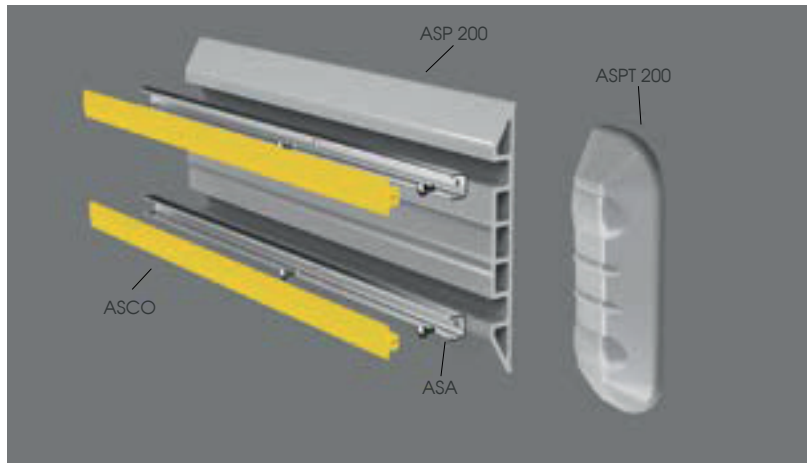

ASP 200



Length **4.000 mm**
 Packing **2 pz / box**
 Colour **B** **W**



ASPT 200



Packing **10 pz / box**
 Colour **B** **D**

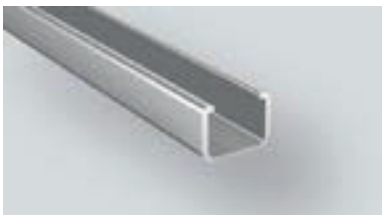
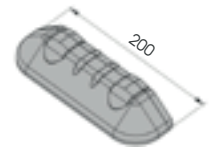

ASA

Material **aluminium**
 Length **4.000 mm**
 Packing **8 pz / bundle**



ASCO



Packing **2 pz / box**
L = 32.000 mm
 Colour **A** **B** **W** **D** **G**

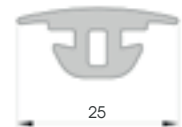

Wall Protection



WALL HUG 1000
2000
3000
4000

Length 1000/2000/3000/4000
Packing unpacked
Colour 

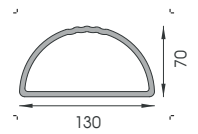

WALL BFLEX 1000
2000
3000
4000

Length 1000/2000/3000/4000
Packing unpacked
Colour 

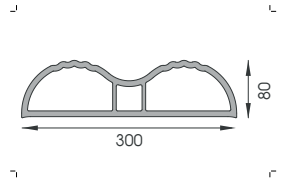

NEWS



LOFT BARRIER

WORLD'S FIRST FIXED PROTECTION SYSTEM FOR SUSPENDED AREAS



FLEXI LINE

CORNER BUMPER GUARDS



FENCE LINK

THE ADAPTABLE STRONGEST SOLUTION FOR RACK-ENDS



Now available
CUSTOMISED RACK PROTECTOR,
new version of rack protector
processed upon request!

CUSTOMISED RACK PROTECTOR

Fixing accessories



TM5

Hole required \varnothing 8.5
Neutral polyethylene. 100/500 Pcs. / bag.



TS9

Hole required \varnothing 5
White or grey nylon. 1000 Pcs. / bag.



TB14 - TB20

Hole required \varnothing 4-5
Steel / aluminium (white for \ddot{A} 4)
500 Pcs. / box.



TF14 - TF20

Hole required \varnothing 5-6.5
Aluminium. 500 Pcs. / box.



M12 - M16

HILTI ANCHOR BOLT
Hole required \varnothing 12-16
Galvanized steel.



S12 - S16

HILTI ANCHOR BOLT
Hole required \varnothing 10-14
Galvanized steel.



B12 - B16 - B20

HILTI INSERT
Hole required \varnothing 22-28-32
Galvanized steel.



S12FH

ANCHOR BOLT
Hole required \varnothing 10
Galvanized steel.
Countersunk.



SF12 - SF16 - SF20

Hole required \varnothing 14-18-24
Stainless steel.



M16 INOX

HILTI INSERT
Hole required \varnothing 16
Stainless steel.



KIT ROD 70-120 ZINCATA

HILTI INSERT
Hole required \varnothing 38-56
Galvanized steel.



KIT ROD 70-120 INOX

HILTI INSERT
Hole required \varnothing 38-56
Galvanized steel.



FR

HILTI CHEMICAL ANCHOR
300 ML

Fixing accessories



FIX P90

Galvanized steel and painted.



COVER 90 RE

Galvanized steel and painted. 8 Pcs. / box.



FIX P90 INOX

Stainless steel.



FIX P150

Galvanized steel and painted.



COVER 150 RE

Galvanized steel and painted.



FIX P150 INOX

Stainless steel.



FIX P150 FH

Galvanized steel and painted.
Countersunk.



FULL FRAME BASE

Galvanized steel and painted.



SHOCK ABSORBER PAD

Soft material, optional for FIXP150.

Colours

A	B	D	E	F	G	H	I	K	L	M
RED RAL 3002	GREY RAL 7040	BLACK RAL 9005	WHITE RAL 9010	WHITE RAL 9002	BLUE RAL 5005	GREEN RAL 6029	SILVER RAL 9006	LIGHT GREY RAL 7035	DARK GREY RAL 7024	LIGHT YELLOW RAL 1018

Cleaner resistant	Cheap	Easy to clean	YES	NO
Quick assembly	Long resistance	Good thermal insulation		
Shockproof	Good waterproof	Non toxic	Class V0 self-extinguishing fire resistance	

MPM srl reserves the right, at any time, to introduce the necessary changes and improvements to its products.
Any small imperfection in the products and in the materials used are due to the processing method.
Any reproduction of this brochure, even in part, is forbidden.



**THE WORLD'S TOP LOGISTICS
PROFESSIONALS CHOOSE OUR
QUALITY MADE IN ITALY**





SOME OF OUR REFERENCES



OUR INSTALLATION



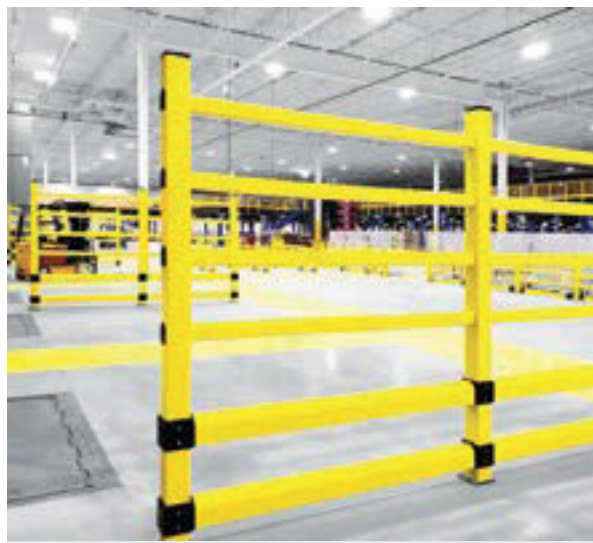



OUR INSTALLATION



EXCEPTIONAL HYGIENE

 Saudi Arabia, P.O Box 53407,
Jeddah 21583 Al Khayyat Tower,
Office No. 230

 +966 12 66 333 18
 +966 12 66 332 38
 info@exceptionalco.com

 www.exceptionalco.com