

**EXCEPTIONAL
HYGIENE**

TREEVOS



THE FUTURE IN INDUSTRIAL
LED LIGHTING

INDUSTRIAL, WAREHOUSE AND AGRICULTURAL BUILDINGS, SPORTS PREMISES, TRANSPORT TERMINALS, PARKING LOTS AND GARAGES, WORKSHOPS AND LABORATORIES WITHOUT EXPLOSION HAZARD.

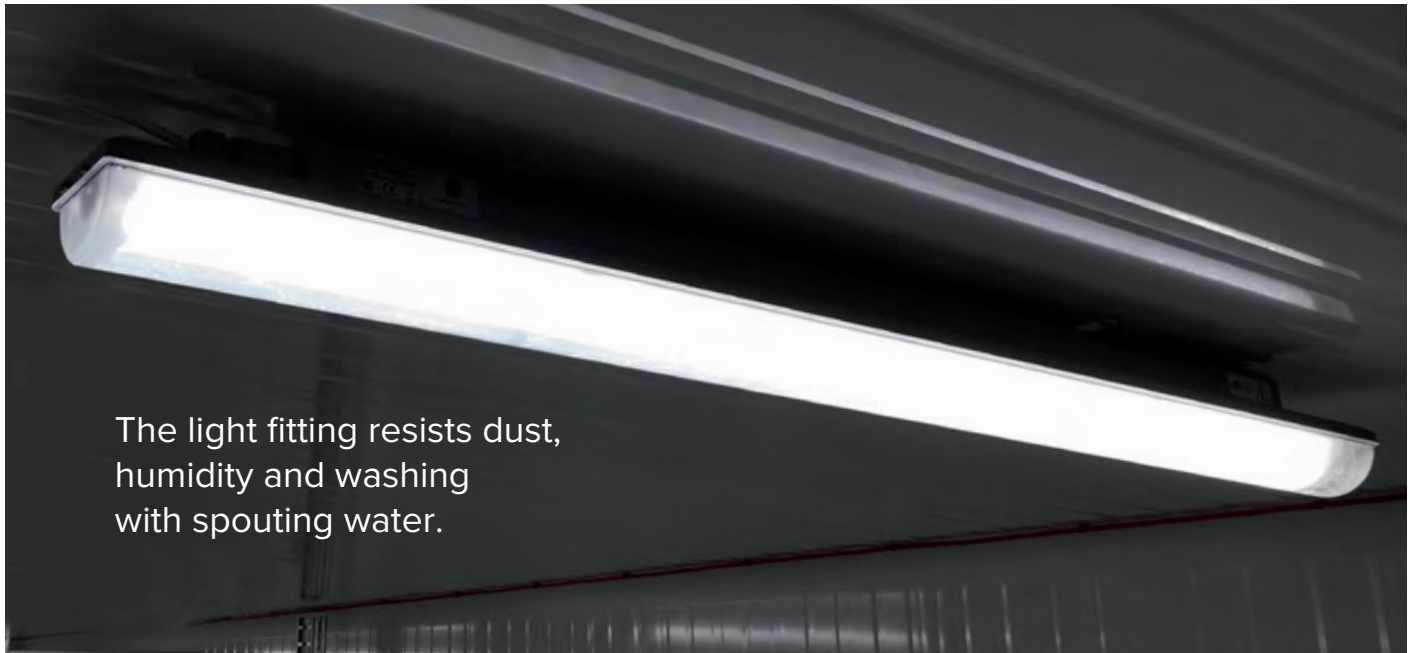

THE BODY AND THE DIFFUSER ARE MADE OF PC MATERIAL WHICH HAS HIGH MECHANICAL RESISTANCE AGAINST IMPACT AND DEFORMATION.

A CHEMICALLY RESISTANT VERSION MADE OF ABS POLYMER AVAILABLE ON REQUEST.

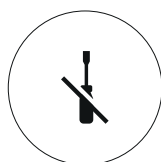

SIMPLE
INSTALLATION

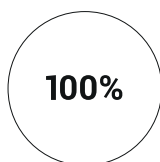

100% QUALITY
CONTROL



IP66
IP69

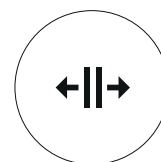

VARIABLE
MOUNTING PITCH

SPECIAL SOLUTION

INNOVA PC INNOVA WB PC INNOVA NB PC	INNOVA ABS INNOVA WB ABS INNOVA NB ABS	INNOVA ABS RED	INNOVA ABS BLUE
industrial buildings warehouses sports premises transport terminals parking lots laboratories	farms stables production premises car wash units industrial buildings	cow barns	poultry farms
Chemically resistant			
Human centric lighting / Tunable white			

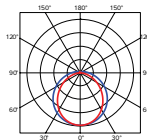

INNOVA
 INNOVA ABS
 4 - 8 m

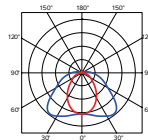

INNOVA WB
 INNOVA WB ABS
 WIDE BEAM
 2.5 - 5 m

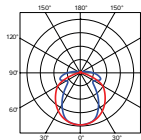

INNOVA NB
 INNOVA NB ABS
 NARROW BEAM
 8 - 12 m



THE STRUCTURAL DESIGN OF THE LIGHT FITTING (IP69) ALLOWS EVEN PLACEMENT IN THE FOOD-PROCESSING INDUSTRY - HACCP.

A POSSIBILITY OF WASHING WITH SPLASHING HOT WATER UP TO 80 °C.



QUALITY AND ADVANTAGE



- Only top-quality materials sourced from within Europe.
- Suitable for chemically aggressive environment and also for the food industry (HACCP certification).
- For indoor and outdoor installations even without a shelter.
- Light fitting protection IP66 and IP69 (possibility of washing with splashing hot water up to 80 °C)
- High resistance to dust, water and impact of IK10
- Certification: ENEC, CB, CE, ESC, HACCP, DLG (only INNOVA ABS)
- High temperature resistance in a range from $t_a = -25\text{ °C}$ to $t_a = 50\text{ °C}$
- Resistance to salty environment
- Optional arrangement of light fittings in line, without gaps



- Easy cleaning and maintenance without need to replace the light sources
- Eliminated risk of mechanical and electro static damage to LED chips
- Variable suspensions pitch (optional installation of light fitting even on an existing structure)
- Optional through-wiring

Has successfully completed an ammonia resistance and cleaning distance test (safe distance 15 cm) performed by the German Agricultural Society (DLG).

Innova ABS is perfectly suitable for agricultural premises with animals.



SUTABLE EQUIVALENT OF FLUORESCENTFITTING

INNOVA 1.4ft PC (ABS) 3200/840

= PRIMA 136 - 1 x 36W

INNOVA 1.4ft PC (ABS) 6400/840

= PRIMA 236 - 2 x 36W

INNOVA 1.5ft PC (ABS) 4000/840

= PRIMA 158 - 1 x 58W

INNOVA 1.5ft PC (ABS) 8000/840

= PRIMA 258 - 2 x 58W

TECHNICAL SPECIFICATIONS



• Diffuser:

translucent PC

transparent PC with Fresnel lenses
(high mechanical resistance, UV stability)

translucent AC (only INNOVA ABS)

transparent AC with Fresnel lenses
(only INNOVA ABS)

• Body

grey PC or ABS (both high mechanical resistance, UV stability)

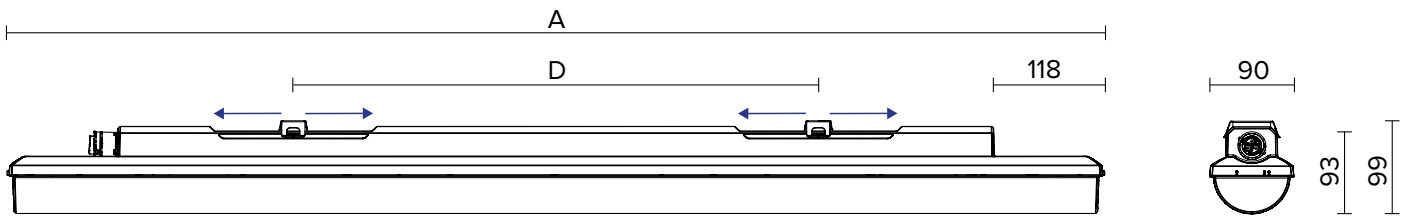

- Ventilation membrane in the body to prevent condensation
- Optional constant luminous flux (CLO) in DALI version
- Electric equipment: LED modules, fixed output driver or DALI driver
- The package includes: stainless steel hooks and brackets
- Fully automatic %100 control offunctionality and tightness (leak test) during production



- **Maximum light fitting efficiency: 142 lm/W**
- **150 lm/W (and more) versions available on request**

- CRI > 4000 :80 K - standard
- CRI > 3000 :80 K, 5000 K, 6500 K - on request
- CRI > 3000 :90 K, 4000 K - on request

QUICK AND SIMPLE INSTALLATION

Connectors with 3, 5, 7 poles, wire section 1.5 or 2.5 mm²



STUCCHI 37xx



STUCCHI 38xx



DL 06



Interconnection
easy, fast and efficient mounting

directly to a ceiling or a wall

suspension with the use
of stainless hooks

attachment with the use
of side hangers

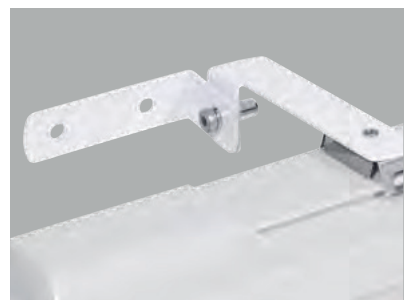

Variable installation pitch.
Simple substitution/replacement
of the original fitting.

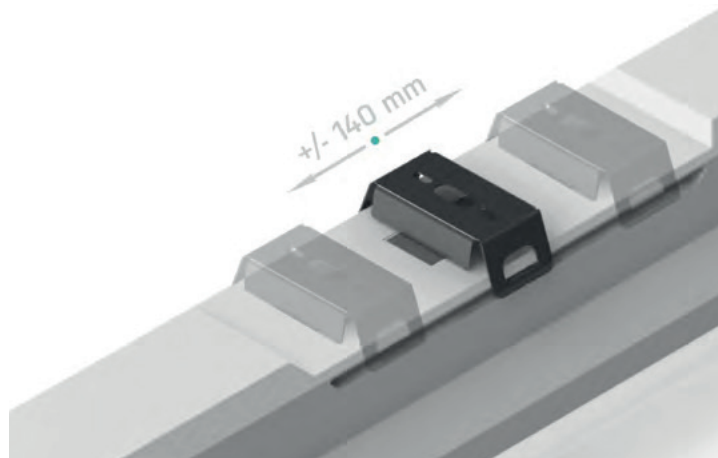



INNOVA ABS BLUE

calming down poultry

- LED module in blue spectrum 450 nm
- stimulates growth and sexual development of poultry
- blue light has stress-relieving properties for hens. If hens are placed in a room with blue light, they perceive the room as being dark
- improves feed conversion rate
- 2-in-1 solution - standard 4000 K LED + blue light in 1 luminaire = economic solution

INNOVA ABS RED

efficient production

- LED module in red spectrum 625 nm
- does not disturb the sleep cycles of cows and workers can do all usual tasks including milking
- optimal use of red light may increase milk production by 6-10 %
- 2-in-1 solution - standard 4000 K LED + red light in 1 luminaire = economic solution

TUNABLE WHITE



industry, healthcare, office, school, hospitality, hotel, restaurant

INDUSTRY

- daylight simulation / night shifts
- increase concentration and efficiency



- a module that boosts circadian rhythms (body temperature, blood pressure, alertness, attention, digestive, immune system activity).

HEALTHCARE , OFFICE SCHOOLS

- daylight simulation
- increase awareness and learning

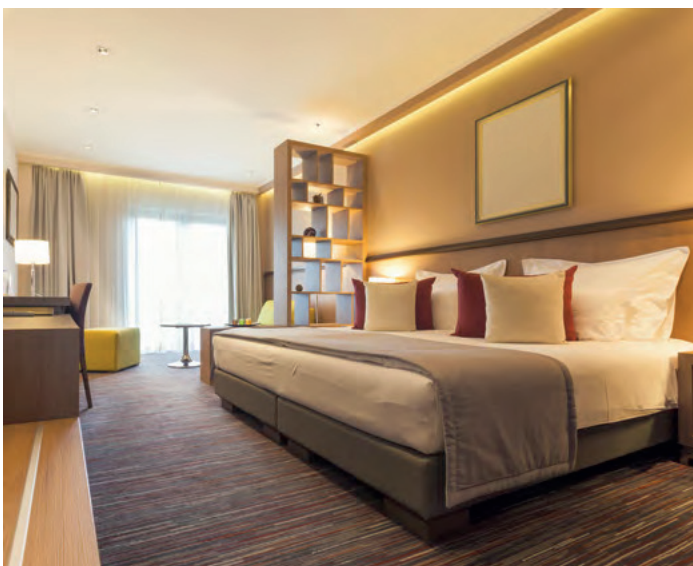

- possibility to adjust correlated colour temperature (CCT) from warm to cool white 2700-6500 K
- dimming function (Lighting Interface DALI)

HOSPITALITY, HOTELS RESTAURANTS

- mainly mood and scene setting
- create atmosphere and cosiness

INNOVA

INNOVA ABS

for areas with high ceilings 4 to 8 m

Type	Max. ambient temperature [°C]	Luminous flux of LED modules [lm]	Luminous flux of light fitting [lm]	Power consumption [W]	System efficacy [lm/W]	Net weight [kg]	A [mm]	D [mm]
INNOVA 1.4ft PC (ABS) 840/2600	50	2600	2470 (2340)	18	137 (130)	1,5	1175	420 - 700
INNOVA 1.4ft PC (ABS) 840/3200	50	3200	3050 (2890)	22	139 (131)	1,5	1175	420 - 700
INNOVA 1.4ft PC (ABS) 840/4400	45	4400	4180 (3960)	30	139 (132)	1,5	1175	420 - 700
INNOVA 1.4ft PC (ABS) 840/6400	45	6400	6030 (5710)	43	140 (133)	1,5	1175	420 - 700
INNOVA 1.4ft PC (ABS) 840/8800	40	8800	8110 (7860)	58	140 (136)	1,6	1175	420 - 700
INNOVA 1.5ft PC (ABS) 840/3250	50	3250	3000 (2840)	22	136 (129)	1,8	1455	700 - 980
INNOVA 1.5ft PC (ABS) 840/4000	50	4000	3770 (3570)	27	140 (132)	1,8	1455	700 - 980
INNOVA 1.5ft PC (ABS) 840/5500	45	5500	5270 (4990)	37	142 (135)	1,8	1455	700 - 980
INNOVA 1.5ft PC (ABS) 840/8000	45	8000	7570 (7170)	54	140 (133)	1,8	1455	700 - 980
INNOVA 1.5ft PC (ABS) 840/11000	40	11000	9950 (9620)	71	140(135)	1,9	1455	700 - 980

INNOVA NB

INNOVA NB ABS

for areas with high ceilings 8 to 12 m

Type	Max. ambient temperature [°C]	Luminous flux of LED modules [lm]	Luminous flux of light fitting [lm]	Power consumption [W]	System efficacy [lm/W]	Net weight [kg]	A [mm]	D [mm]
INNOVA 1.4ft NB PC (ABS) 840/4400	45	4400	3850	30	128	1,5	1175	420 - 700
INNOVA 1.4ft NB PC (ABS) 840/6400	45	6400	5540	43	129	1,5	1175	420 - 700
INNOVA 1.5ft NB PC (ABS) 840/5500	45	5500	4850	37	131	1,8	1455	700 - 980
INNOVA 1.5ft NB PC (ABS) 840/8000	45	8000	6960	54	129	1,8	1455	700 - 980

INNOVA WB

INNOVA WB ABS

for areas with high ceilings 2,5 to 5 m

Type	Max. ambient temperature [°C]	Luminous flux of LED modules [lm]	Luminous flux of light fitting [lm]	Power consumption [W]	System efficacy [lm/W]	Net weight [kg]	A [mm]	D [mm]
INNOVA 1.4ft WB PC (ABS) 840/2600	50	2600	2270	18	126	1,5	1175	420 - 700
INNOVA 1.4ft WB PC (ABS) 840/3200	50	3200	2810	22	128	1,5	1175	420 - 700
INNOVA 1.4ft WB PC (ABS) 840/4400	45	4400	3850	30	128	1,5	1175	420 - 700
INNOVA 1.4ft WB PC (ABS) 840/6400	45	6400	5540	43	129	1,5	1175	420 - 700
INNOVA 1.5ft WB PC (ABS) 840/3250	50	3250	2750	22	125	1,8	1455	700 - 980
INNOVA 1.5ft WB PC (ABS) 840/4000	50	4000	3470	27	129	1,8	1455	700 - 980
INNOVA 1.5ft WB PC (ABS) 840/5500	45	5500	4850	37	131	1,8	1455	700 - 980
INNOVA 1.5ft WB PC (ABS) 840/8000	45	8000	6960	54	129	1,8	1455	700 - 980





THE COST OF THE INSTALLATION OF **120 PCS LUMINAIRES**

PARAMETERS	STANDARD CONNECTION	INNOVA	ADVANTAGES AND BENEFITS
ASSEMBLY TO:	Terminal block	Connector	VERY EASY ASSEMBLY
WHO CONNECTS THE LIGHTS?	Electrician	Assembler	NO NEED OF QUALIFICATIONS
WHAT IS THE FEE?	25 – 55€ per hour	17 – 30 € per hour	25 – 8 € SAVED
TIME EXPENDITURE	60 hours	30 hours	50 % TIME SAVED
COST OF THE LIGHTS ASSEMBLY	1 500 – 3300 €	510 – 900 €	990 – 2400 € SAVED 72,8 – 66 % COST SAVED

EXCEPTIONAL HYGIENE

 Saudi Arabia, P.O Box 53407,
Jeddah 21583 Al Khayat Tower,
Office No. 230

 +966 12 66 333 18
 +966 12 66 332 38
 info@exceptionalco.com

 www.exceptionalco.com