



ALWAYS THE BEST **PROFILES**

JULY 2019



COLD ROOMS
AND REFRIGERATED
CABINETS **PROFILES**

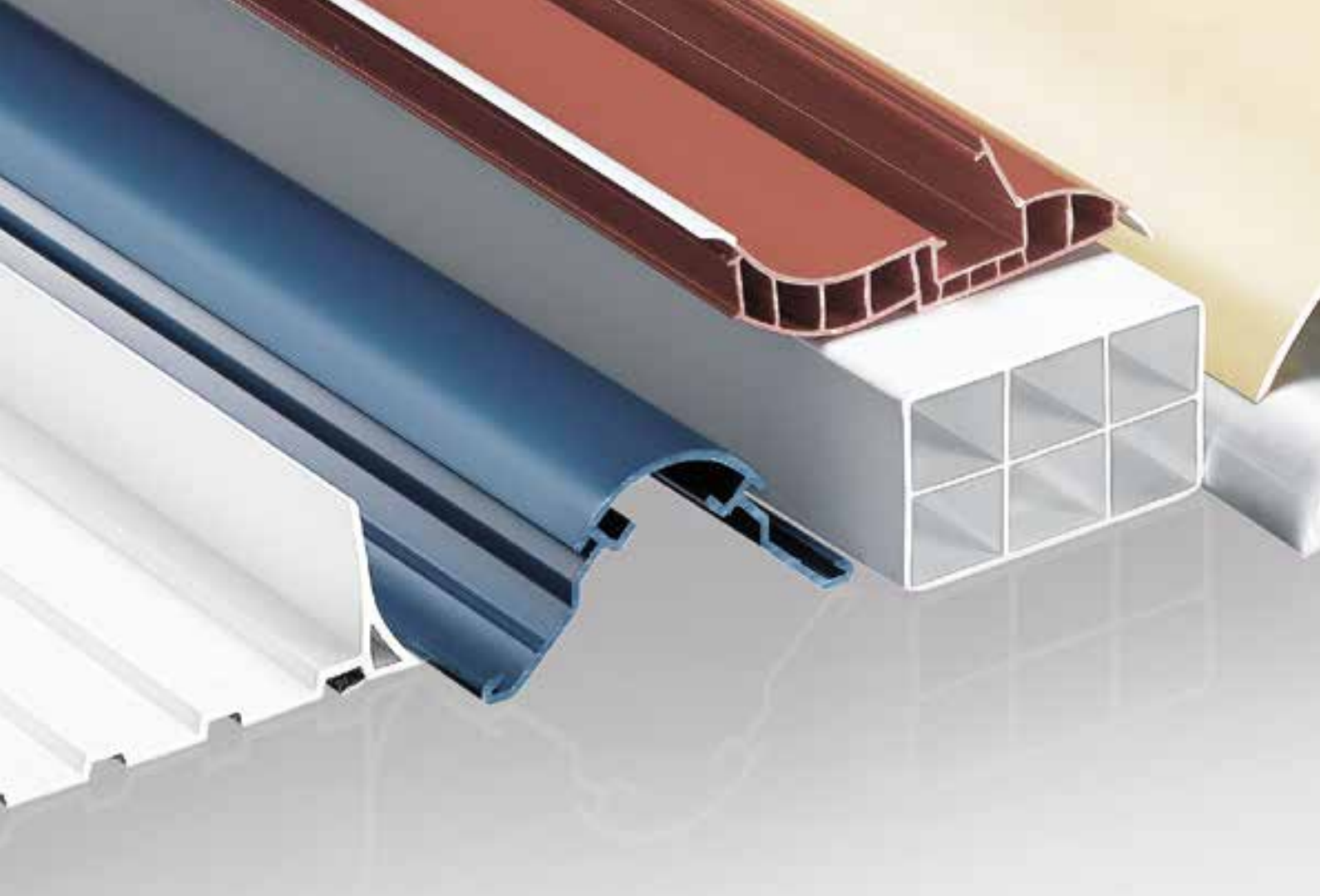

WE PRESENTS
OUR NEW LINES
AND **OUR NEW**
PROFILES' CREATIONS



ALWAYS CREATED FOR YOUR NEEDS
ALWAYS THE BEST COLD SYSTEMS PROFILES



CONTENTS

01	Guard Rails and Bollards	page 08	15	Gaskets	page 64
02	PVC Panels	page 18	16	Accessories for panels	page 68
03	Foamed System	page 20	17	Trims	page 72
04	Hermetic System	page 22	18	T Suspension	page 74
05	Standard System	page 26	19	Bumper 30	page 76
06	Speed System	page 30	20	Bumper 50	page 78
07	Modular System	page 34	21	Bumper 80	page 80
08	Channels	page 38	22	Bend 80	page 82
09	Fixer System	page 42	23	Bumper Superflex 80	page 84
10	Pillar System	page 46	24	Bumper Modular	page 86
11	Kerb	page 48	25	Wall Protection	page 88
12	Antishock System	page 52	26	Bumper 150	page 92
13	Door Frame	page 54	27	Bumper Floor	page 94
14	Door Leaf	page 60	28	Wheel System	page 96





THE COMPANY L'AZIENDA

TURNKEY PRODUCTS ON DEMAND

Right from the customer's request the company follows project development, production through to the final product. Our technical team deals with each stage of the project, mould production and testing aimed at offering the best solutions.

MPM A GROWING COMPANY

The quality of M.P.M products is the result of combining the skills and motivation of a team with advanced materials and technologies. Dynamic, enterprising and flexible this company has been serving the plastics industry since 1985 offering extruded plastic profiles to order as well as a range of its own products.

PRODOTTI SU MISURA CHIAVI IN MANO

L'azienda segue fin dal primo stadio la realizzazione del progetto, dalla richiesta del cliente al prodotto finito. Lo staff tecnico cura le diverse fasi di progettazione, la costruzione degli stampi e il collaudo, attento a proporre le soluzioni migliori.

UN'AZIENDA IN CRESCITA

La qualità dei prodotti M.P.M. deriva dalla riuscita combinazione tra le competenze e la motivazione dell'équipe di lavoro e l'alto livello delle tecnologie e dei materiali. Dinamica, intraprendente e flessibile, l'azienda lavora dal 1985 al servizio della più esigente imprenditoria nell'impegnativo settore dell'estrusione di materie plastiche, producendo profili per conto terzi e su proprio catalogo.

CUSTOMIZED PRODUCTS

PRODOTTI PERSONALIZZATI

ALWAYS DYNAMIC, ALWAYS RELIABLE

Young yet skilled in offering turnaround solutions to satisfy the various problems this market faces, the staff at M.P.M, a team of technicians and experts motivated and qualified in their fields, combine superior quality with fast product production.

3D DESIGN

The company has invested substantially in design: advanced 3D software and product prototype development has led to a reduction in problems and errors in mould manufacturing.

SEMPRE DINAMICA, SEMPRE AFFIDABILE

Giovane ma adeguatamente preparato a risolvere con tempestività le diverse problematiche insite nel difficile settore, lo staff M.P.M. è composto da tecnici e professionisti motivati, efficienti e capaci di coniugare l'eccellenza qualitativa con la massima rapidità nell'esecuzione del prodotto.

PROGETTAZIONE 3D

L'azienda ha investito molto nel campo della progettazione: l'utilizzo di avanzati software 3D e la successiva prototipazione rapida hanno consentito la riduzione di inconvenienti ed errori nella fase di produzione dello stampo.



360° GLOBAL SERVICE

UN SERVIZIO A 360°



1 PROJECT PLAN
STUDIO PROGETTO



2 MOULD MANUFACTURING
PRODUZIONE STAMPO



3 MOULD REALIZED
STAMPO FINITO

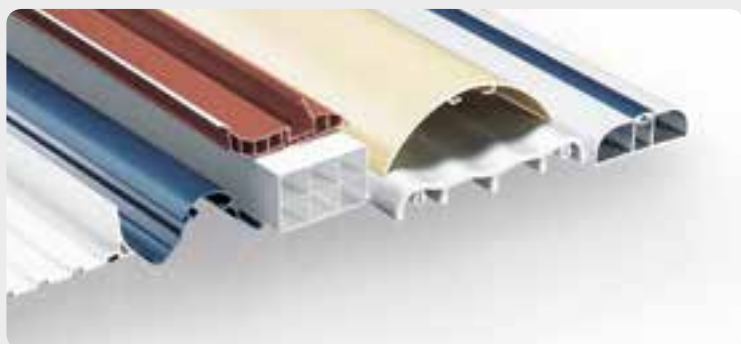

5 PRODUCTS RANGE
GAMMA PRODOTTI



4 PROFILES MANUFACTURING
PRODUZIONE PROFILI

6 EXPORT



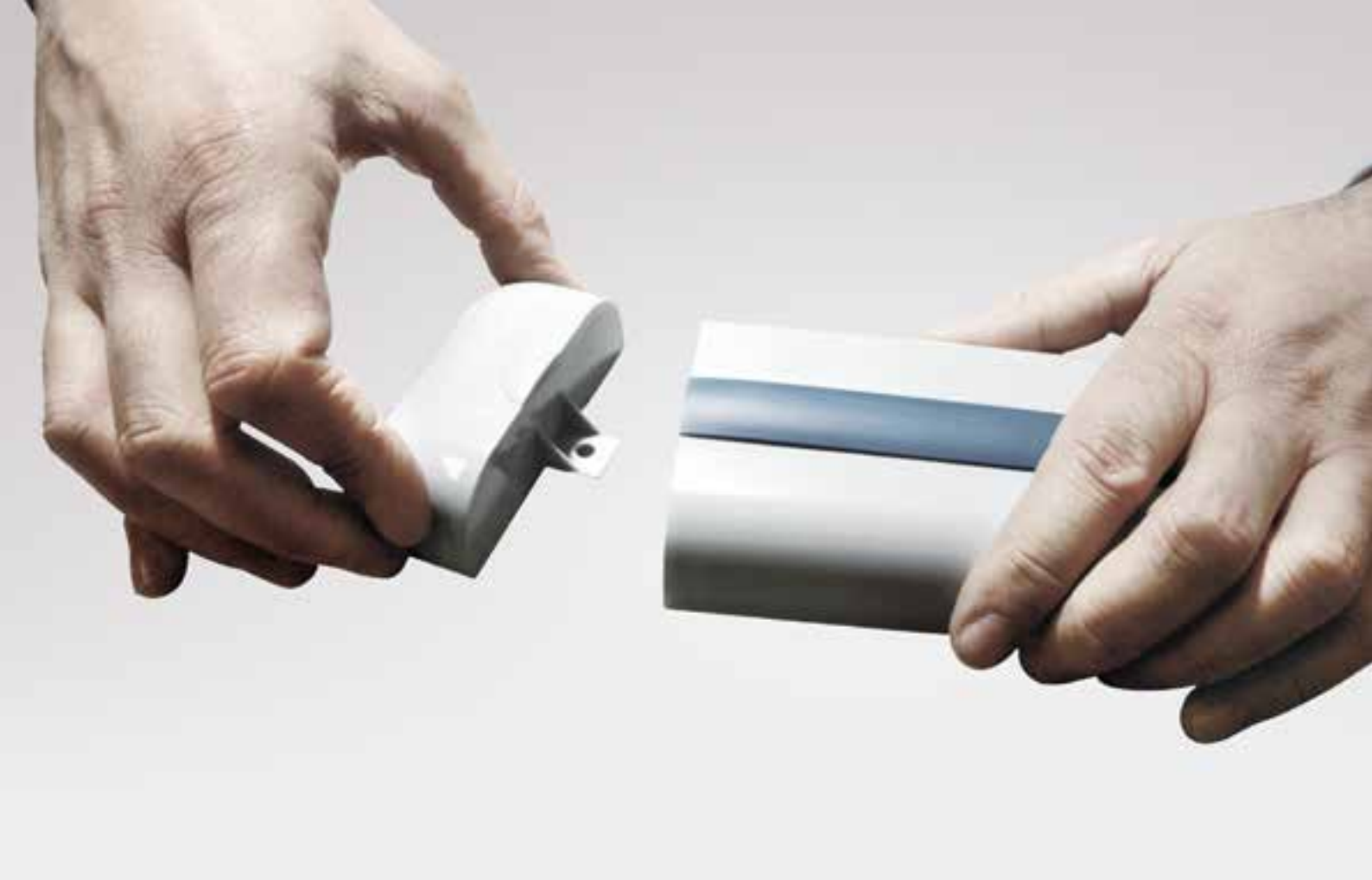

DETAILED SOLUTIONS SOLUZIONI MIRATE

SOLUTIONS FOR DIFFERENT FIELDS

Thanks to the close working partnership with specialist laboratories, M.P.M develops product mixes ideal for extruding rigid, expanded, co-extruded profiles and for producing soft seals of varying hardness. The products are available with polished or matt finishes for interior and exterior use, they can be anti-shock, self-extinguishing, acid resistant satisfying requirements of a number of industries spanning from furniture, refrigeration, door and window producers to the building trade.

ABS	acrylonitrile butadiene styrene
PE	polyethylene
TPE	thermoplastic rubber
SEBS	thermoplastic rubber
PMMA	polymethyl methacrylate
PP	polypropylene
PS	polystyrene
PVC	polyvinyl chloride
PVCE	expanded foam polyvinyl chloride
PUR	polyurethane

SOLUZIONI PER OGNI SETTORE

Grazie alla collaborazione di laboratori specializzati, M.P.M. progetta le miscele di materiale più adatte all'estrusione di profili rigidi, espansi, coestrusi e di guarnizioni morbide a diversa durezza. I prodotti possono essere con finiture lucide od opache, per interni o esterni, antiurto, autoestinguenti e resistenti agli acidi, soddisfacendo in particolare le esigenze delle industrie del mobile, del freddo, del serramento e dell'edilizia.

ABS	acrilonitrile-butadiene-stirolo
PE	polietilene
TPE	gomma termoplastica
SEBS	gomma termoplastica
PMMA	polimetilmetacrilato
PP	polipropilene
PS	polistirolo-polistirene
PVC	policloruro di vinile
PVCE	policloruro di vinile espanso
PUR	poliuretano



01

GUARD RAILS AND BOLLARDS



Guard Rails is a new bumper system specific for the protection of the walls resistant against trolleys movements. Designed by following an innovative technical design that combines speed and simplicity in the steps of installation and cleaning. Available in different lengths.

Guard Rails è un sistema profili antiurto specifico per la protezione delle pareti dai carrelli in movimento. Progettato seguendo un innovativo disegno tecnico che coniuga rapidità e semplicità nelle fasi di installazione e pulizia. Disponibile in diverse lunghezze.

Guard Rails est un nouveau système bumper, spécifique pour protéger les murs contre les mouvements des charriots. Étudié avec un modern dessin qui regroupe la rapidité et la facilité pendant l'installation et le nettoyage. Disponible en différents longueurs.

Bollard is designed to protect access to gates or big doors from huge traffic or simply to mark restricted areas for pedestrians. Fully equipped with fixing accessories.

Bollard è ideato per proteggere l'accesso a cancelli o portoni dalla movimentazione di mezzi pesanti o semplicemente per impedire l'ingresso di pedoni. Provvisto di accessori di fissaggio.

Bollard est étudié pour protéger l'accès aux portes ou entrées de grand trafic ou simplement pour marquer les zones de passage piétons. Equipé avec les accessoires d'installation.



Guard Rails and Bollards

ROD 70



RE
EASY TO
REMOVE AND
TO REPLACE

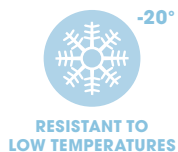

**M20
GALVANISED STEEL**

Fixing accessory available also in stainless steel



ROD PE 70 266 RE

Packing
Colour

6 pz / box

Drill Ø 38
Equipped with accessories

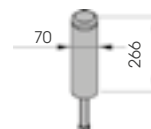

Guard Rails and Bollards

ROD 120



RE
EASY TO
REMOVE AND
TO REPLACE



**M30
GALVANISED STEEL**

Fixing accessory available also in stainless steel



**ROD PE 120 433 RE
560 RE**

Drill Ø 56
Equipped with accessories

Packing
Colour **M**

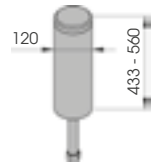

Guard Rails and Bollards

ROD FLOOR 70



**QUICK
INSTALLATION
WITH
EXPANSION
SCREW**



**M16
GALVANISED STEEL**

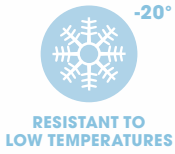

**RF 70 500
1000
1500**

Length **500 / 1000 / 1500 mm**
Packing **unpacked on pallet**
Colour **M**

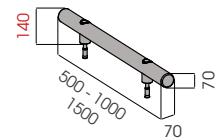

Equipped with accessories



**RF 70 2000
3000**

Length **2.000 / 3.000 mm**
Packing **unpacked on pallet**
Colour **M**

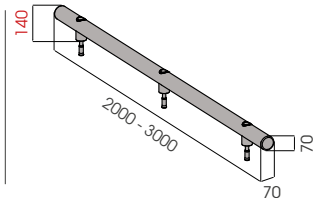

Equipped with accessories



ROD FLOOR 120



**M20
STAINLESS STEEL**

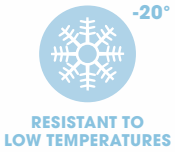
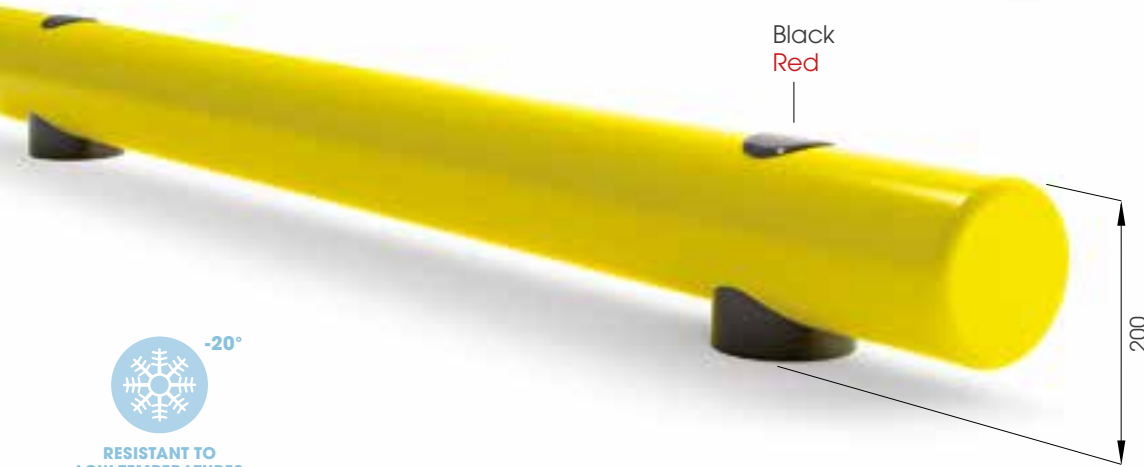

**RF 120 500
1000
1500**

Length **500 / 1000 / 1500 mm**
Packing **unpacked on pallet**
Colour **M**

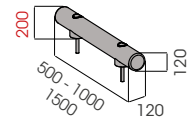

Equipped with accessories



**RF 120 2000
3000**

Length **2.000 / 3.000 mm**
Packing **unpacked on pallet**
Colour **M**

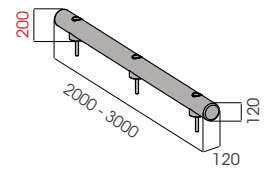

Equipped with accessories



Guard Rails and Bollards

GRD 90



**FAST
AND EASY
TO INSTALL**



**M12
GALVANISED STEEL**



GRD 90 250

Packing Colour **unpacked on pallet**

B M

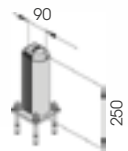

Equipped with accessories



Guard Rails and Bollards

GRD 150



FAST
AND EASY
TO INSTALL



M12
GALVANISED STEEL



GRD 150 * 500
800
1150

Packing Colour **unpacked on pallet**
B M

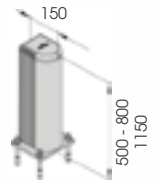

Equipped with accessories



Guard Rails and Bollards

GUARD RAIL 90



**QUICK
INSTALLATION
WITH
EXPANSION
SCREW**



**M16
GALVANISED STEEL**

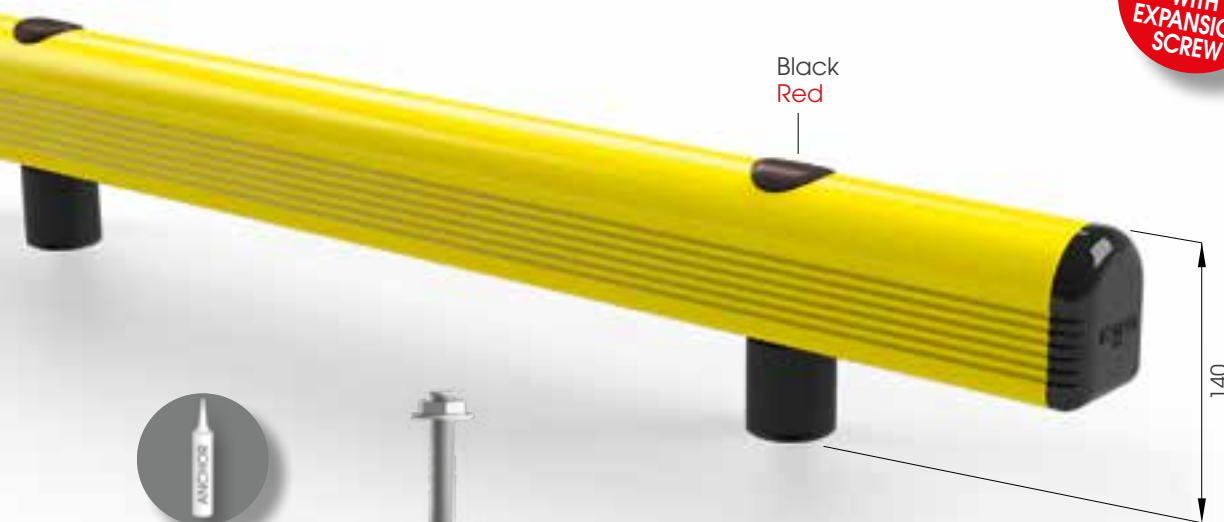

ALTERNATIVE FIXING
HIGH RESISTANCE WITH RESIN



**M16
STAINLESS STEEL**



GR 90 500
750
1000
1500

Length 500 mm
Packing 4 pz / box

Length 750 / 1000 / 1500 mm
Packing 2 pz / box

Colour B M

Equipped with accessories

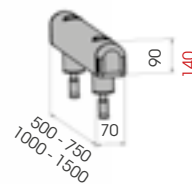

GR 90 2000
3000
4000

Length 2.000 / 3.000 / 4.000 mm
Packing 2 pz / box
Colour B M

Equipped with accessories

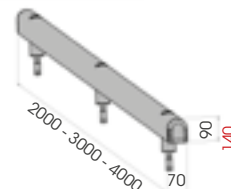

GUARD RAIL 150



**M20
STAINLESS STEEL**

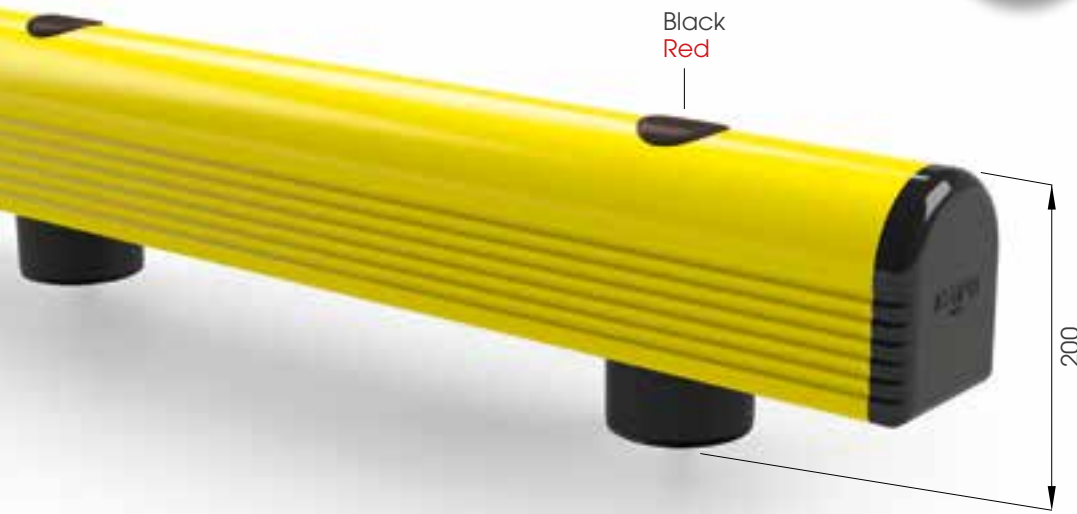

GR 150 500
750
1000
1500

Length **500 / 750 / 1000 / 1500 mm**
Packing **unpacked on pallet**
Colour B M

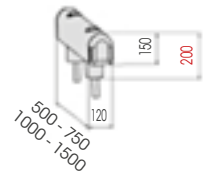

Equipped with accessories



GR 150 2000
3000
4000

Length **2.000 / 3.000 / 4.000 mm**
Packing **unpacked on pallet**
Colour B M

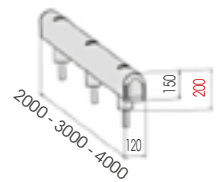

Equipped with accessories



02

PVC PANELS



PVC sheets to renovate fastly and cheaply the walls of cold rooms and cold store.

Lastre in PVC per il rinnovo rapido ed economico delle pareti nelle celle e nei magazzini frigoriferi.

Plaques en PVC pour renover rapidement et a bas prix les murs de chambres froides et de depots frigorifiques.

DIFFERENT
SIZES ON
REQUEST



PF 300

Foamed inside

FOAMED
INSIDE

Length **3.000 / 4.000 mm**
Packing **3 pz / bag**
Colour **E**



PR 300

Length **3.000 / 4.000 mm**
Packing **3 pz / bag**
Colour **E**



PJ

To install with PR 300 and PF 300

Length **3.000 mm**
Packing **10 pz / box**
Colour **E**

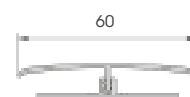

PA

To install with PR 300 and PF 300

Length **3.000 mm**
Packing **10 pz / box**
Colour **E**



PT

To install with PR 300 and PF 300

Length **3.000 mm**
Packing **10 pz / box**
Colour **E**

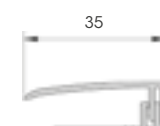

03

FOAMED SYSTEM

Nuovo battiscopa completamente schiumato all'interno, facile da installare e senza alcun sportello. Provvisto di alette morbide evita il passaggio di acqua e sporco. Ideale per cucine industriali, sale bianche e celle frigo.

New plinth completely foamed inside, easy to install and without flaps. Thanks to its soft fins, no dirt and no water are allowed. Ideal for industrial kitchens, cold rooms and cleanrooms.

Nouveau plinthe à ailettes souples complètement expansée, afin d'éviter le passage d'eau et des bactéries. Facile à installer, parfait pour cuisines industrielles, salles stériles et chambres froides.



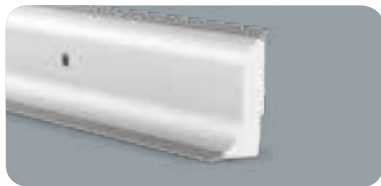
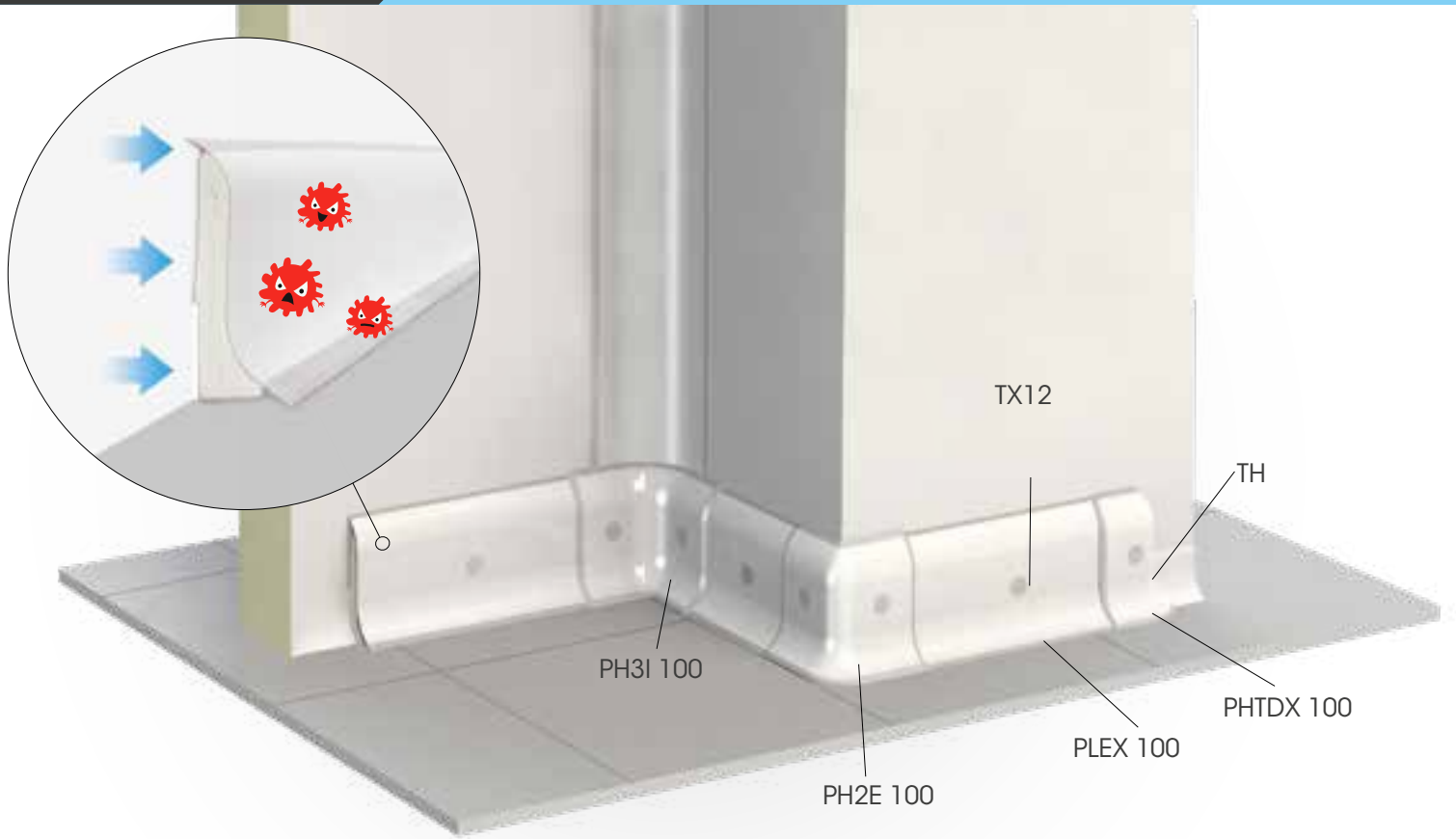

PLEX 100

To install with TX12

PERFORATED

Packing Length Colour
8 pz / box
4.000 mm
A E K

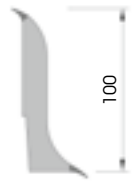

PH2I 100

To install with TH



Packing Colour
50 pz / box
E K



PH3I 100

To install with TH



Packing Colour
50 pz / box
E K



PH2E 100

To install with TH



Packing Colour
50 pz / box
E K



PHTDX 100

To install with TH



Packing Colour
100 pz / box
E K



PHJ 100

To install with TH



Packing Colour
to be defined
E K

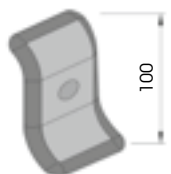

04

HERMETIC SYSTEM

NEW BI
MATERIAL
CAPS

NEW CAPS ALSO TO BE
USED WITH PL 100

NOUVEAUX EMBOUTS À
UTILISER AUSSI AVEC PL 100

NUOVI TAPPI UTILIZZABILI
ANCHE CON PL 100



New sanitary system, excellent water and dirty resistant, provided with a new plinth with a large flap to make the installation easier and bi material caps to grant hermetic closing. To be used with standard hygienic corners.

Nuovo sistema profili sanitari con un battiscopa dotato di grande sportello per facilitare l'installazione. Completo di tappi in bimeriale per una chiusura ermetica. Ottima tenuta dell'acqua e dello sporco. Utilizzabile con angoli sanitari standard.

Nouveau système sanitaire, résistant à l'eau et à l'impureté, doté d'une plinthe avec une grande porte pour faciliter l'installation et accessoires injectées en bi matériel pour une fermeture hermétique. À utiliser avec les congés d'angle standards.



Hermetic System



CS 65

Length **4.000 mm**
 Packing **25 pz / box**
 Colour **E F**



CO 65

Length **4.000 mm**
 Packing **25 pz / box**
 Colour **B E F**

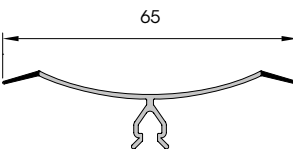

CO 100

Length **4.000 mm**
 Packing **25 pz / box**
 Colour **E F**

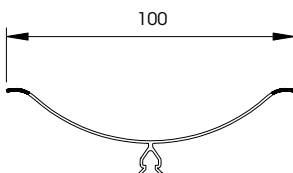

CSP with holes
CSA

Material **CSP plastic**
CSA aluminium
 Length **4000 mm**
 Packing **CSP**
25 pz / box
CSA
25 pz / bundle

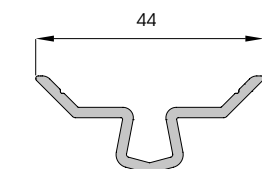

COPF 100-65 with holes
COAF 100-65

Material **COPF plastic**
COAF aluminium
 Length **4.000 mm**
 Packing **COPF 100-65**
25 pz / box
COAF 100-65
25 pz / bundle

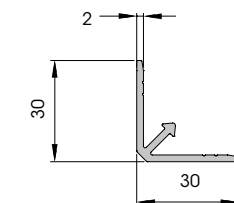

COPF 40 with holes
COAF 40

Material **COPF plastic**
COAF aluminium
 Length **4.000 mm**
 Packing **COPF 40**
25 pz / box
COAF 40
25 pz / bundle

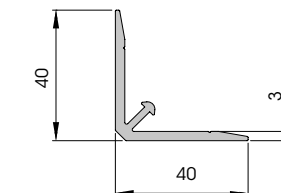

CP 100

Length **4.000 mm**
 Packing **10 pz / box**
 Colour **B E F M**



CPF 100

Material **plastic**
 Length **4.000 mm**
 Packing **10 pz / bag**



CPT 100

Packing **40 pz / box**
 Colour **B E F**

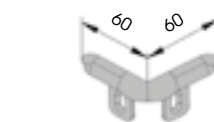



PH 100



Length **4.000 mm**
 Packing **12 pz / box**
 Colour **E F**

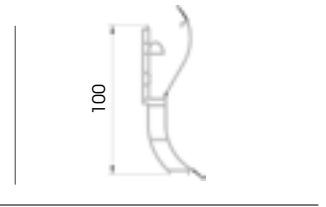

CO3V 65

Packing **100 pz / box**
 Colour **B E F**

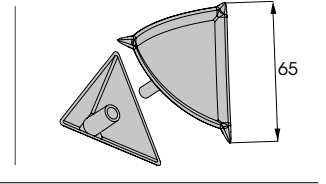

CO3V 100 H
 To install with TH



Packing **100 pz / box**
 Colour **E F**



CO2VE 65
CO2VE 100

Packing **100 pz / box**
 Colour **E F**

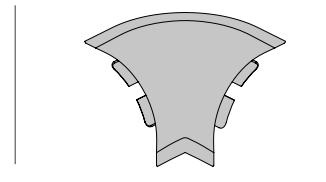

COT 65
COT 100

Packing **100 pz / box**
 Colour **E F**



PH2I 100
 To install with TH



Packing **50 pz / box**
 Colour **E F**



PH3I 100
 To install with TH



Packing **50 pz / box**
 Colour **E F**



PH2E 100
 To install with TH



Packing **50 pz / box**
 Colour **E F**



PHTDX 100
PHTSX 100
 To install with TH



Packing **100 pz / box**
 Colour **E F**



PHJ 100
 To install with TH



Packing **to be defined**
 Colour **E K**



05

STANDARD SYSTEM



Basic hygienic corner with aluminium or pvc guide, with soft fins to fix it to the wall to assure hygiene. It can be used with plinth.

Angolo sanitario classico con supporto in alluminio o pvc. Provvisto di alette morbide per assicurare il fissaggio alle pareti ed evitare il passaggio dello sporco. Perfetta combinazione con il battiscopa a pavimento.

Système d'angle standard hygiénique avec un support en aluminium ou en pvc. Dispose d'ailettes souples assurant une adhésion aux murs afin d'éviter le passage de la poussière. Peut-être utilisé avec des plinthes.



Standard System



CS 45

Length **4.000 mm**
 Packing **50 pz / box**
 Colour **E F**

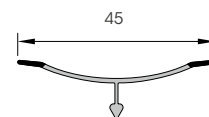

CO 65

Length **4.000 mm**
 Packing **25 pz / box**
 Colour **B E F**

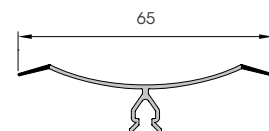

CO 100

Length **4.000 mm**
 Packing **25 pz / box**
 Colour **E F**

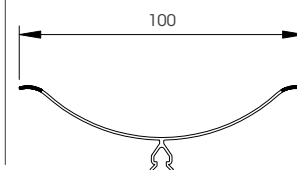

CSP 45

Length **4.000 mm**
 Packing **50 pz / box**

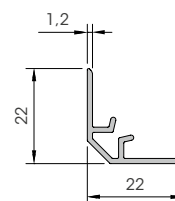

COPF 100-65 with holes
COAF 100-65

Material **COPF plastic**
COAF aluminium
 Length **4.000 mm**
 Packing **COPF 100-65**
25 pz / box
COAF 100-65
25 pz / bundle

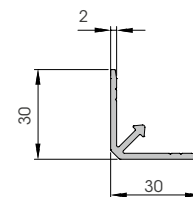

COPF 40 with holes
COAF 40

Material **COPF plastic**
COAF aluminium
 Length **4.000 mm**
 Packing **COPF 40**
25 pz / box
COAF 40
25 pz / bundle

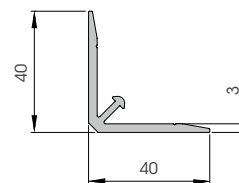

CP 100

Length **4.000 mm**
 Packing **10 pz / box**
 Colour **B E F M**

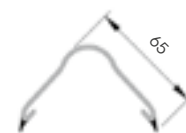

CPF 100

Material **plastic**
 Length **4.000 mm**
 Packing **10 pz / bag**



CPT 100

Packing **40 pz / box**
 Colour **B E F**

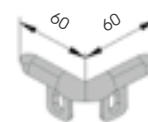



PL 100 R

Length **4.000 mm**
 Packing **10 pz / box**
 Colour **E F**

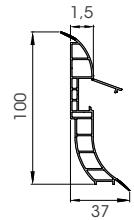

CO3V 45

To install with TM5

Packing **100 pz / box**
 Colour **E**

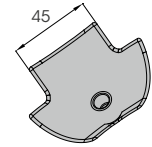

CO3V 65
CO3V 100

Packing **100 pz / box**
 Colour **E F**

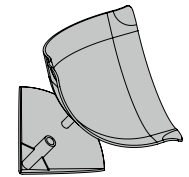

CO2VE 65
CO2VE 100

Packing **100 pz / box**
 Colour **E F**

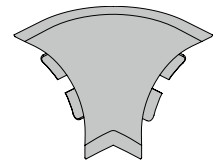

COT 65
COT 100

Packing **100 pz / box**
 Colour **E F**



PL2I 100
PL3I 100

Packing **50 pz / box**
 Colour **E F**

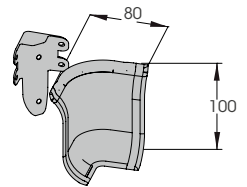

PHJ 100

To install with TH



Packing **to be defined**
 Colour **E K**

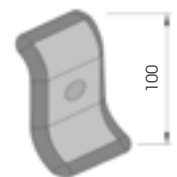

PL2E 100

Packing **50 pz / box**
 Colour **E F**

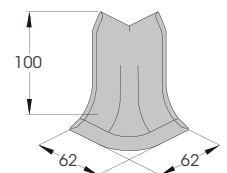

PLTDX 100
PLTSX 100

Packing **100 pz / box**
 Colour **E F**

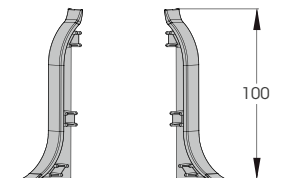

06

SPEED SYSTEM



Hygienic corner system rapid and easy to install, available with fixing buttons on the ending caps which eliminate the need for the wall drilling.

Linea d'angolo sanitario rapida e facile da installare che elimina la foratura alle pareti sostituita da bottoni di supporto ai terminali.

Congé d'angle sanitaire facile à l'installation qui permet d'éviter la perforation de murs grâce à des embouts à pression insérés dans les espaces préforés.

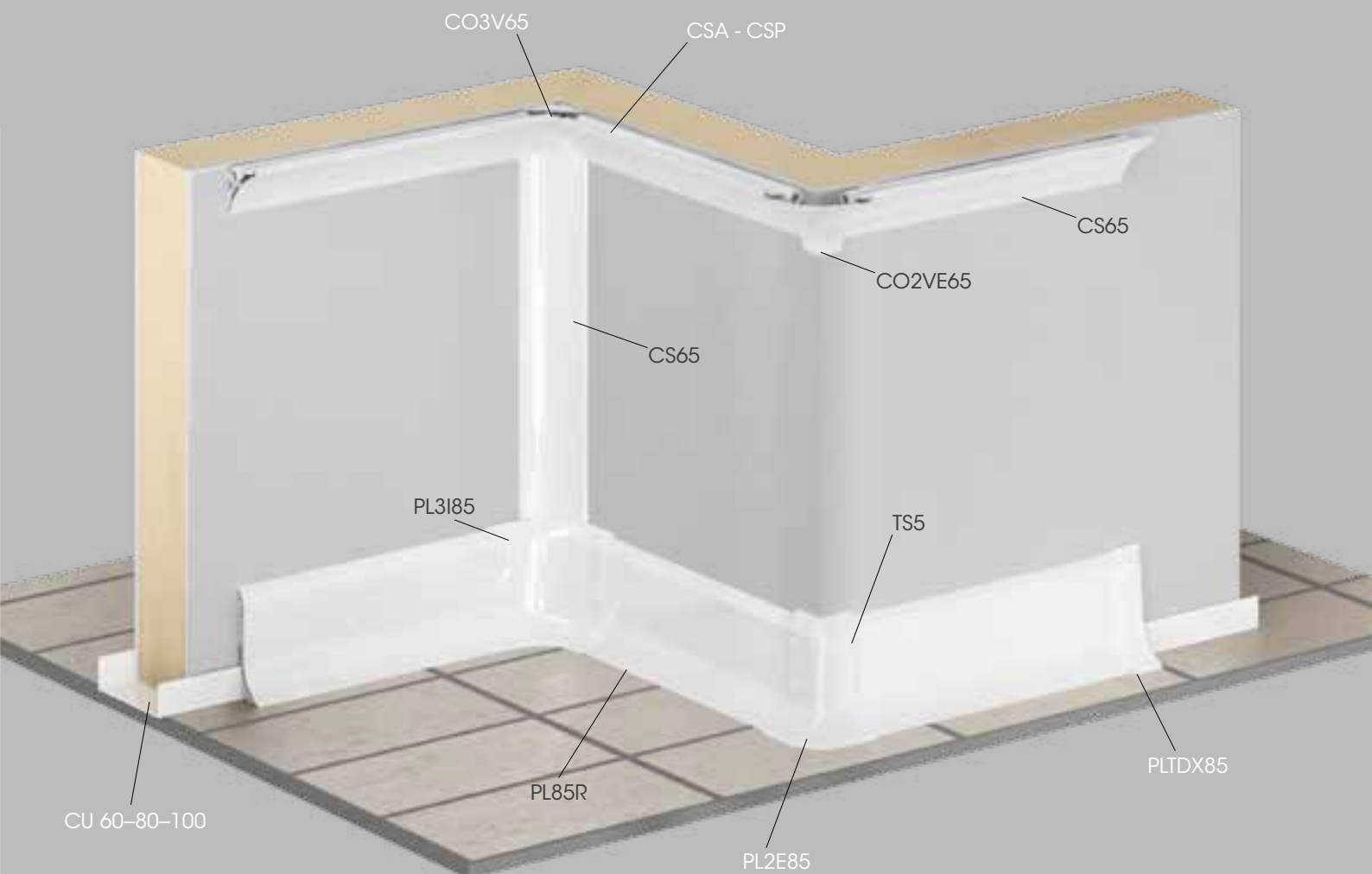

Speed System



CS 65

Length **4.000 mm**
 Packing **25 pz / box**
 Colour **E F**

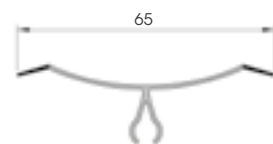

CSP with holes
CSA

Material **CSP plastic**
CSA aluminium
 Length **4.000 mm**
 Packing **CSP**
25 pz / box
CSA
25 pz / bundle

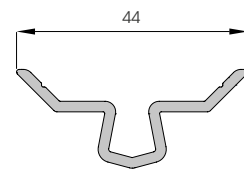

CP 100

Length **2.000 mm**
 Packing **10 pz / box**
 Colour **B E F M**



CPF 100

Material **plastic**
 Length **2.000 mm**
 Packing **10 pz / bag**



CPT 100

Packing **40 pz / box**
 Colour **B E F**

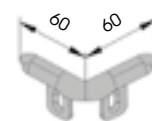

PL 85 R

Length **4.000 mm**
 Packing **15 pz / box**
 Colour **E F**

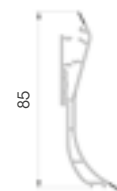

PL2I 85 with holes
PL2I 85 NH without holes

To install with TS5

Packing **50 pz / box**
 Colour **E F**

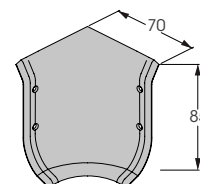

PL3I 85 with holes
PL3I 85 NH without holes

To install with TS5

Packing **50 pz / box**
 Colour **E F**

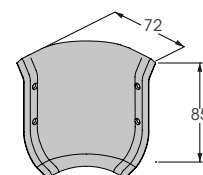

PL2E 85 with holes
PL2E 85 NH without holes

To install with TS5

Packing **50 pz / box**
 Colour **E F**

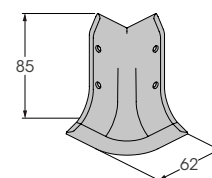



PLTDX 85 with holes
PLTSX 85 with holes
PLTDX 85 NH without holes
PLTSX 85 NH without holes
To install with TS5

Packing 100 pz / box
Colour E F

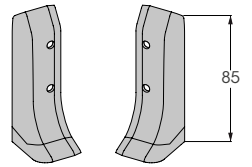

07

MODULAR SYSTEM



Complete system with the possibility to change the size of profiles and internal caps which suit all the solutions. Warranty and easy way to fix it. Hidden screws.

Sistema completo con possibilità di allungamento modulare dei profili e raccordi interni che si adattano a tutte le combinazioni. Garanzia e facilità di fissaggio. Viti a scomparsa.

Système modulable complet avec la possibilité de modifier la taille des profilés et des raccords internes, qui s'adapte alors à toutes les solutions. Solidité garantie et facile à fixer. Vis dissimulées.

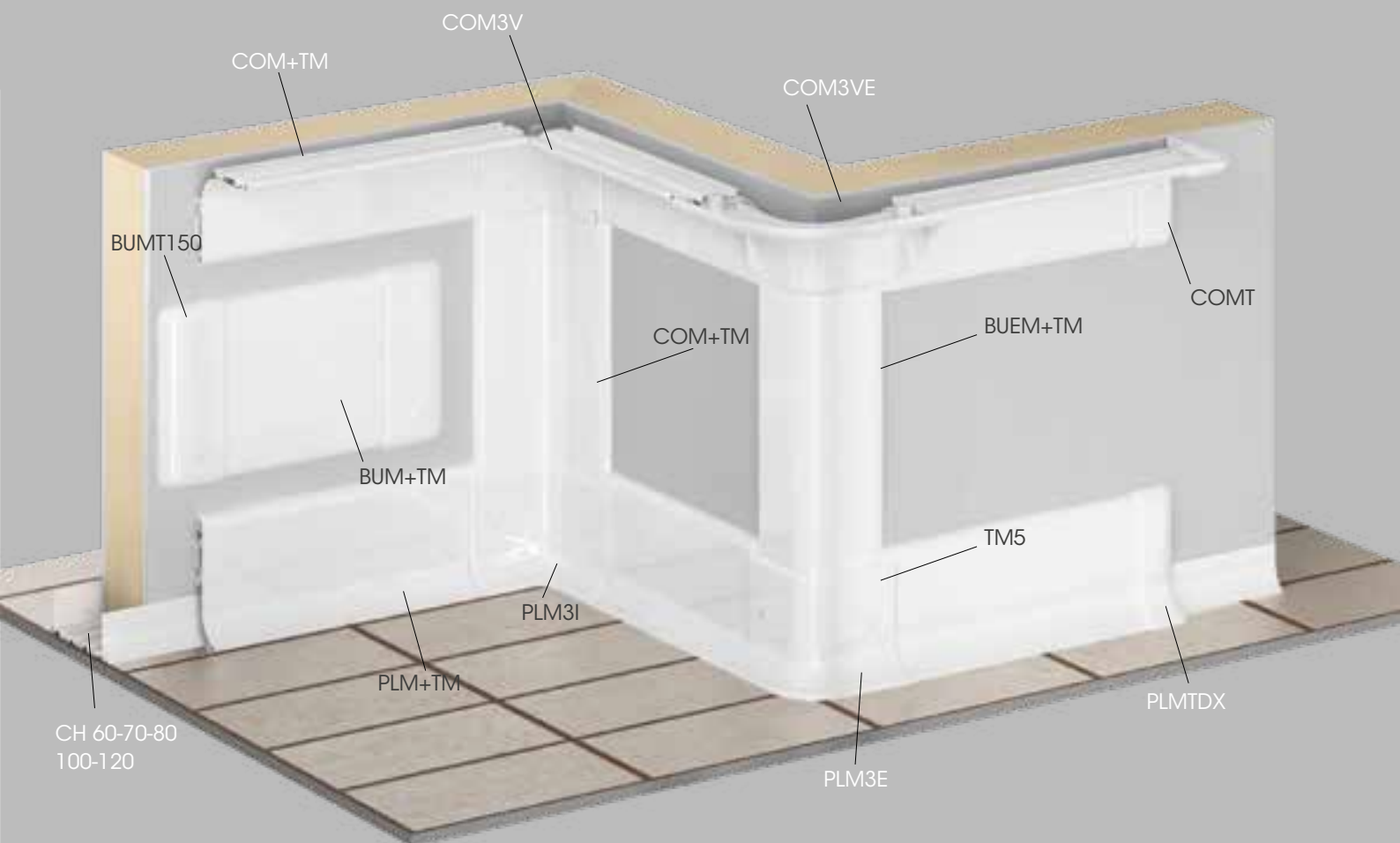

Modular System



TM

Length **4.000 mm**
 Packing **40 pz / box**
 Colour **B E**



EXM

Length **4.000 mm**
 Packing **20 pz / box**
 Colour **B E**

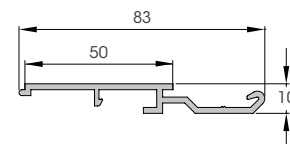

PLM

Length **4.000 mm**
 Packing **10 pz / box**
 Colour **B E**

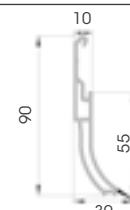

COM

Length **4.000 mm**
 Packing **10 pz / box**
 Colour **B E**

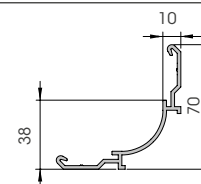

BUEM

Length **4.000 mm**
 Packing **10 pz / box**
 Colour **B E**

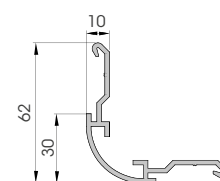

BUM

Length **4.000 mm**
 Packing **8 pz / box**
 Colour **A B E G H M**

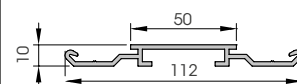

PLM31

To install with TM5

Packing **50 pz / box**
 Colour **B E**

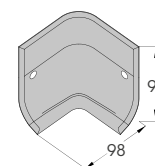

PLM3E

To install with TM5

Packing **50 pz / box**
 Colour **B E**

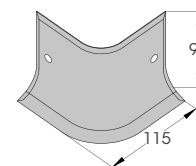

PLMT DX
PLMT SX

To install with TM5

Packing **100 pz / box**
 Colour **B E**

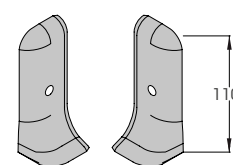



COM3 V

To install with TM5

Packing 50 pz / box

Colour B E

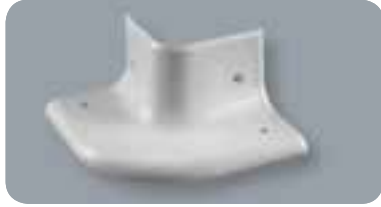
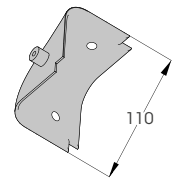

COM3 VE

To install with TM5

Packing 25 pz / box

Colour B E

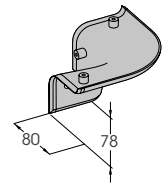

COMT

To install with TM5

Packing 50 pz / box

Colour B E

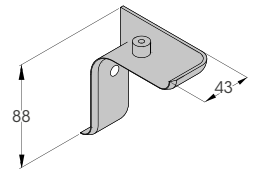

BUMT 150

To install with TM5

Packing 50 pz / box

Colour B E

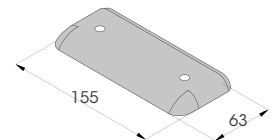

BUMT 250

To install with TS7

Packing 25 pz / box

Colour E

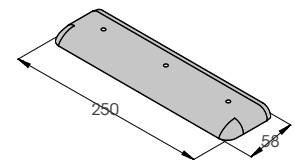

PLN3I 100

To install with TM5

Packing 50 pz / box

Colour B E

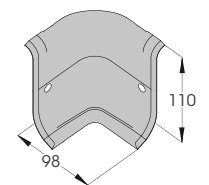

PLN2E 100

To install with TM5

Packing 50 pz / box

Colour B E

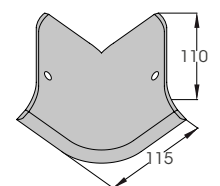

08

**OUR CHANNELS
FIT FOR ALL OUR
PLINTHS**

CHANNELS



Different sizes available with rounded sides and soft fins for a good fit to the floor.
Cheap models available, see CU.

Ampia scelta tra canale grecate con bordi arrotondati e alette morbide per assicurare maggiore tenuta. Disponibili anche in versione più economica, vedi CU.

Plusieurs dimensions sont disponibles, nervurées avec des bords arrondis et des ailettes souples pour permettre une meilleure adhésion au sol. Différents modèles économiques disponibles, voir CU.

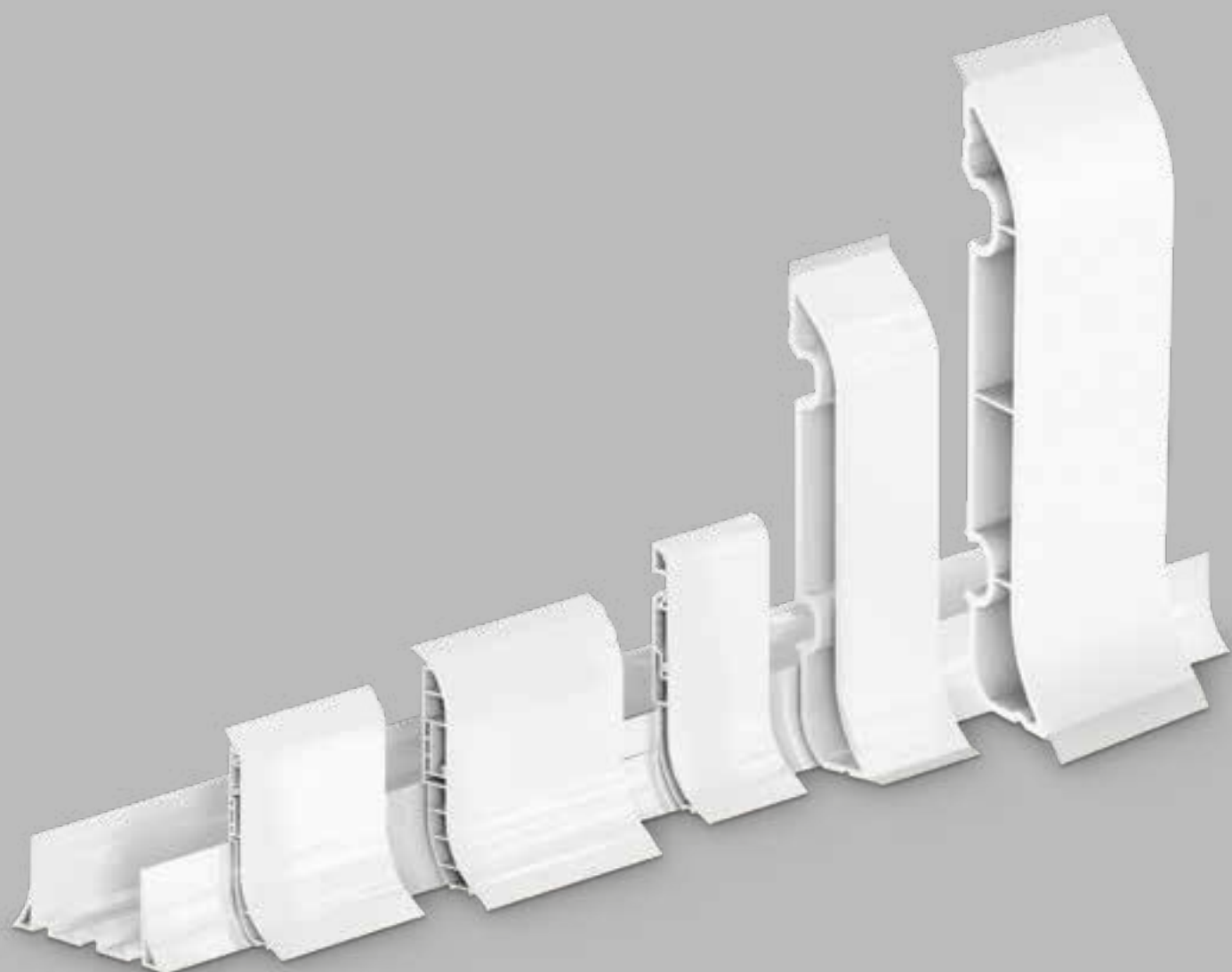

Channels



CH 60

Length **4.000 mm**
 Packing **2 pz / bundle**
 Colour **E F**

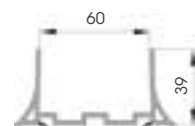

CH 70

Length **4.000 mm**
 Packing **2 pz / bundle**
 Colour **E F**

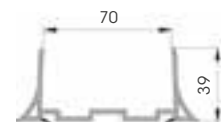

CH 80

Length **4.000 mm**
 Packing **2 pz / bundle**
 Colour **E F**

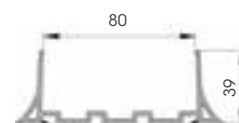

CH 100

Length **4.000 mm**
 Packing **2 pz / bundle**
 Colour **E F**

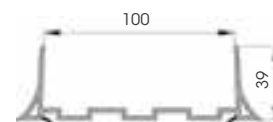

CH 120

Length **4.000 mm**
 Packing **2 pz / bundle**
 Colour **E F**

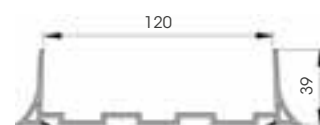

CU 40

Length **4.000 mm**
 Packing **8 pz / bag**
 Colour **E F**

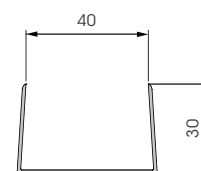

CU 60

Length **4.000 mm**
 Packing **2 pz / bundle**
 Colour **E F**

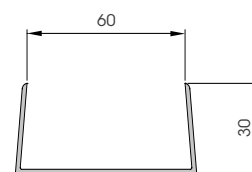

CU 80

Length **4.000 m**
 Packing **2 pz / bundle**
 Colour **E F**

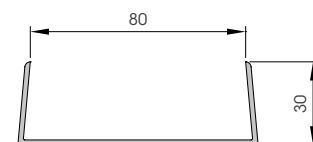

CU 100

Length **4.000 mm**
 Packing **2 pz / bundle**
 Colour **E F**

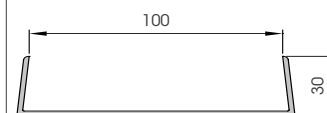

Channels

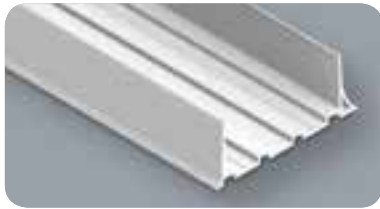

CL 80

Length **4.000 mm**
 Packing **8 pz / box**
 Colour **E F**

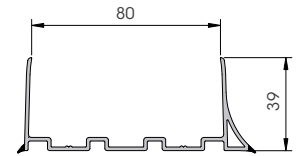

CHA 80

Packing **24 pz / box**
 Colour **E F**



CHA 100

Packing **48 pz / box**
 Colour **E F**

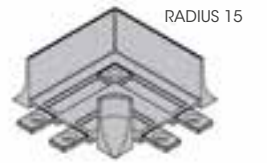

CHA 60 R 15
CHA 80 R 15

Packing **24 pz / box**
 Colour **E F**

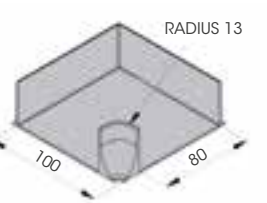

CHA 100 R 15

Packing **48 pz / box**
 Colour **E F**

CLA 80 R 13

To install with
 CL 80

Packing **24 pz / box**
 Colour **E F**

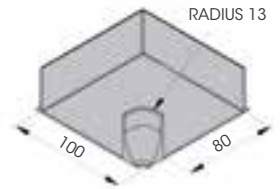

CHL 60
CHL 70
CHL 120

Packing **to be defined**
 Colour **E F**

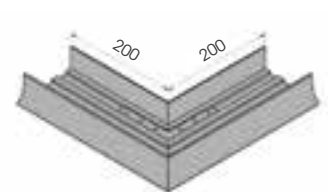

CHT 60
CHT 70
CHT 80
CHT 100
CHT 120

Packing **to be defined**
 Colour **E F**

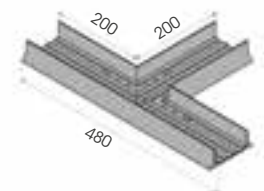

09

FIXER SYSTEM

New and useful system for quick assembly of cold rooms or other buildings using continuous panels.

Innovativo sistema rapido e funzionale per il montaggio di celle frigo o altre strutture a partire da pannelli in continuo.

Système nouveau, rapide et fonctionnel pour l'assemblage de chambres froides ou autres structures à partir de panneaux en continu.

NEW

**ADL / ADLC
TO COMPLETE
THE PROJECT**



**QUICK
AND EASY
FIXING BY
RIVETS**

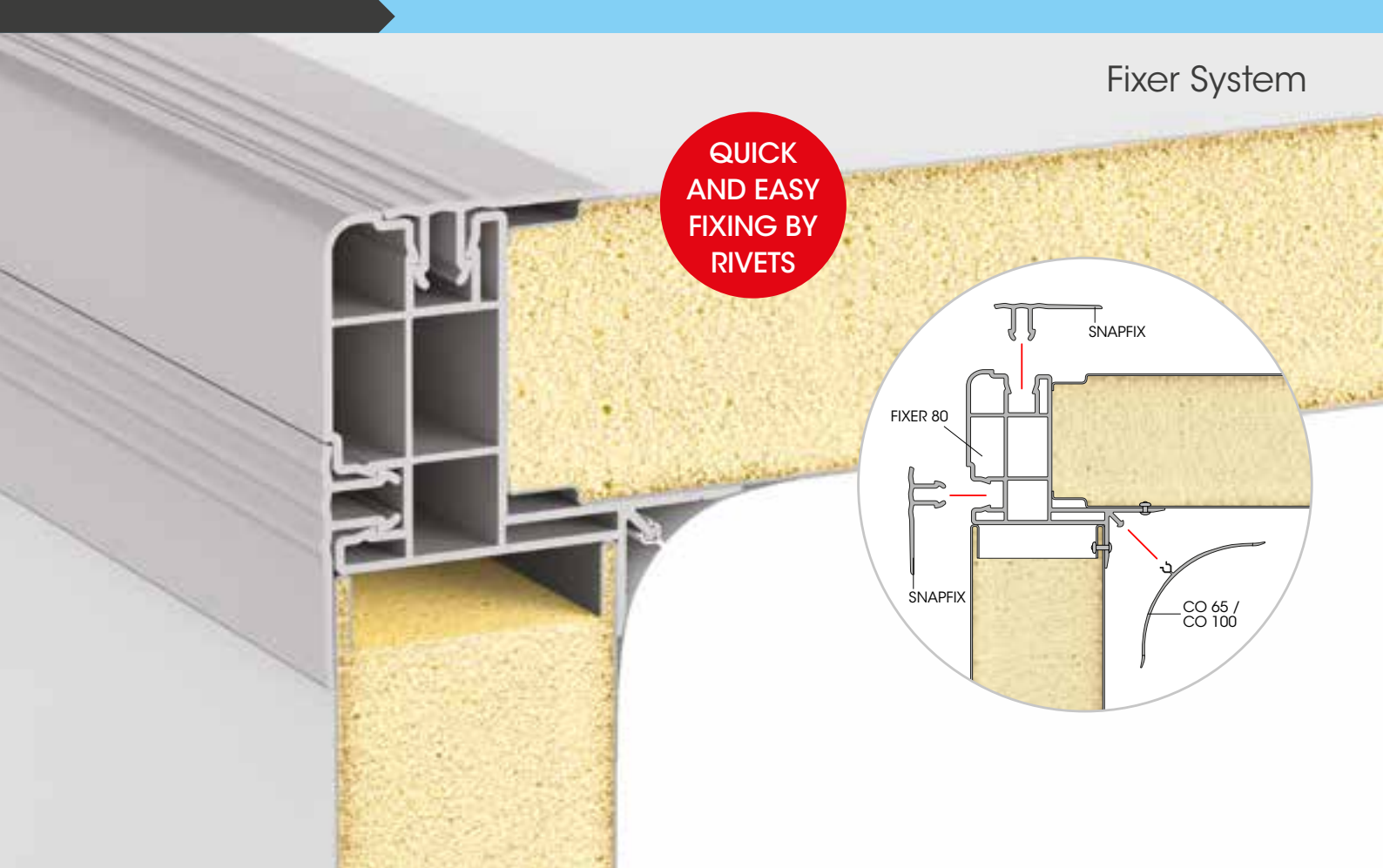

FIXER 80
To install with SNAPFIX

Length **5.800 mm**
On request
Packing **2 pz / box**
Colour **K**

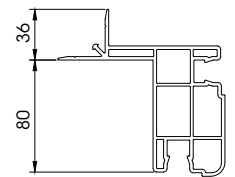

FIXER 100
To install with SNAPFIX

Length **5.800 mm**
On request
Packing **2 pz / box**
Colour **K**

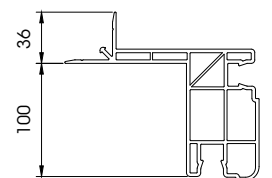

SNAPFIX

Length **5.800 mm**
On request
Packing **4 pz / box**
Colour **K**

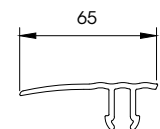

FIT 80 DX
FIT 80 SX

Packing **4 pz / box**
Colour **K**

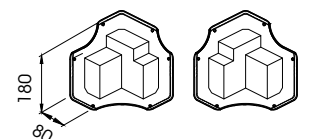

FIT 100 DX
FIT 100 SX

Packing **4 pz / box**
Colour **K**

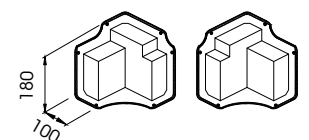

NEW SYSTEM = MORE BENEFITS !

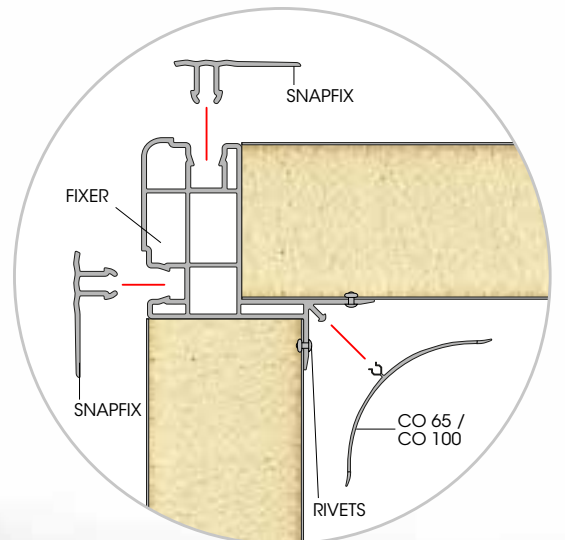
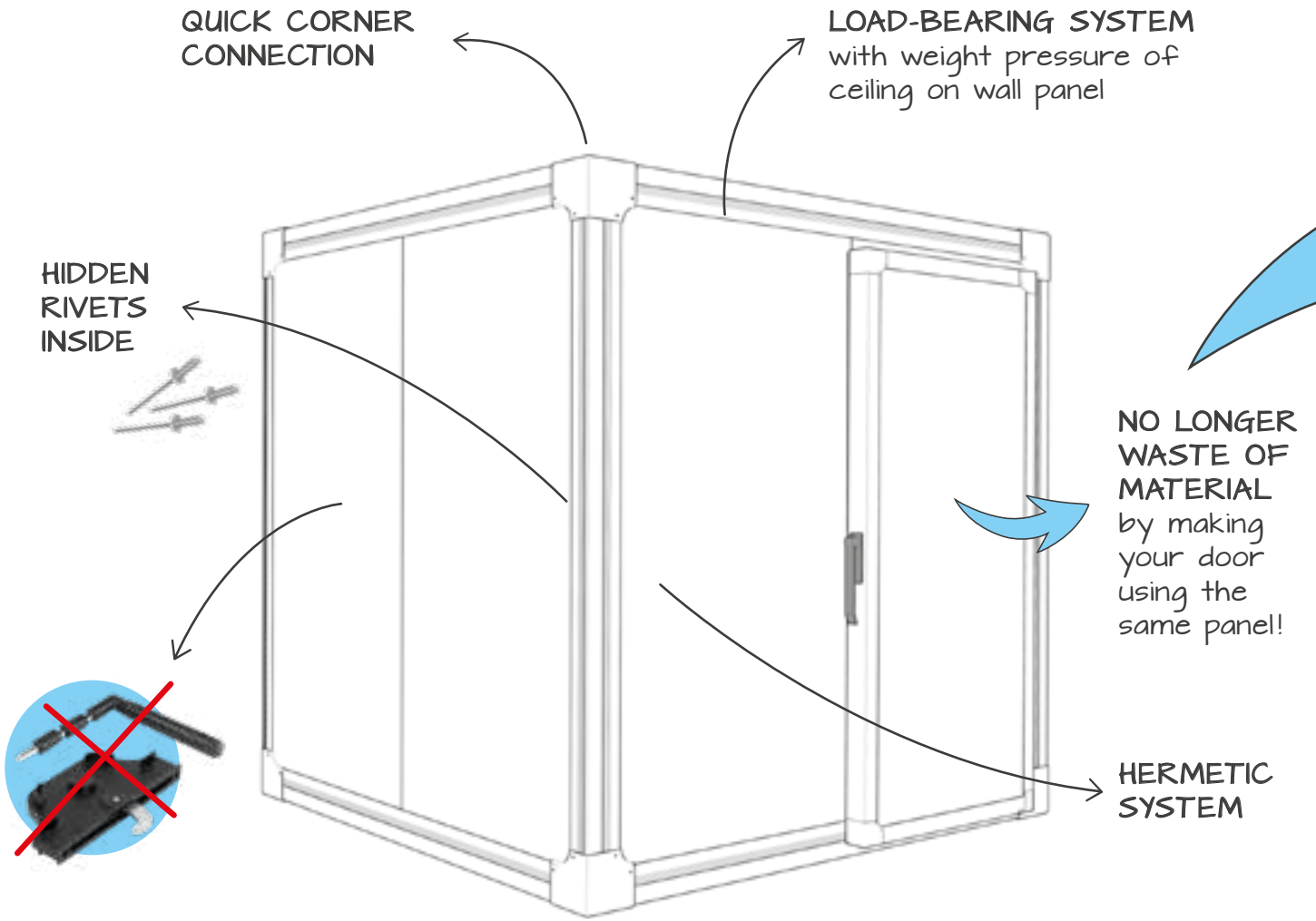

ADL
CORNER

USE
ADLC
AS DOOR
FRAME

USE
ADL
AS DOOR
PROFILE

A REAL REVOLUTION

You can now use
CONTINUOUS PANELS

SAVE TIME AND MONEY



Save time with our quick and easy fixing



Save money with our new modular system



10

PILLAR SYSTEM

Cheap and useful system studied for quick planning and installation of cold rooms. Perfect isolation, equipped with an internal rounded corner for easy cleaning.

Sistema economico e funzionale ideato per la rapida progettazione e gestione delle celle frigorifere. Ottimo isolamento, accessorato con angoli arrotondati all'interno per facilitare la pulizia.

Système pratique et économique étudié pour la réalisation et la gestion de chambres froides. Isolation parfaite, équipé d'angles arrondis à l'intérieur pour faciliter le nettoyage.

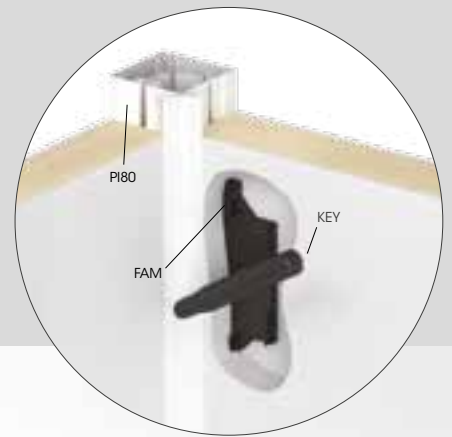

Pillar System

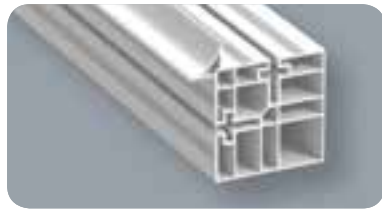

PIT 80

Length **5.000 mm**
 Packing **unpacked on pallet**
 Colour **E**

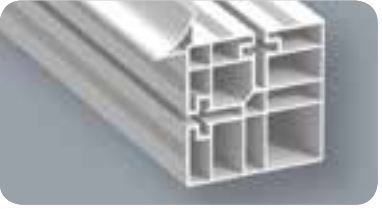
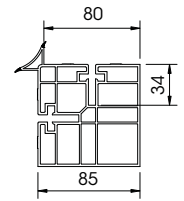

PIT 120

Length **5.000 mm**
 Packing **unpacked on pallet**
 Colour **E**

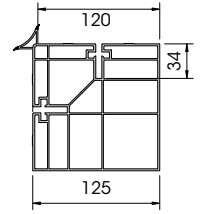

GE

Material **Steel**
 Length **5.000 mm**
 Packing **10 pz / bundle**



FAM

Packing **200 pz / box**
 Colour **D**

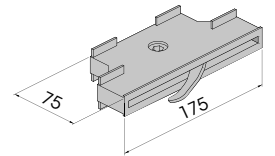

FAF

Packing **200 pz / box**
 Colour **D**

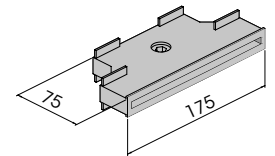

KEY

Packing **100 pz / box**
 Colour **D**

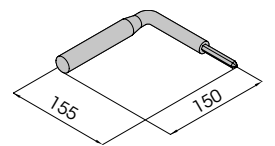

PIC 80

Packing **8 pz / box**
 Colour **E**

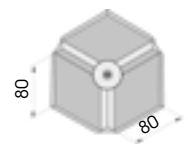

PIC 120

Packing **4 pz / box**
 Colour **E**

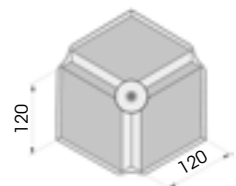

11 KERB

To install with Channels CH and CU
Monta con canale CH e CU
À installer avec les U de sol CH et CU



A large size protection system,
ideal for walls and panels.
Easy to install and clean.
Fully equipped with corner
caps and buttons.

Sistema di protezione di grandi
dimensioni, ideale per muri e
pannelli. Facile da installare e pulire.
Completo di angolari e tappi.

Système de protection de grands
dimensions, idéal pour les murs et
les panneaux. Facile à installer et
à nettoyer. Complété de bouchons
d'angles et d'embouts.

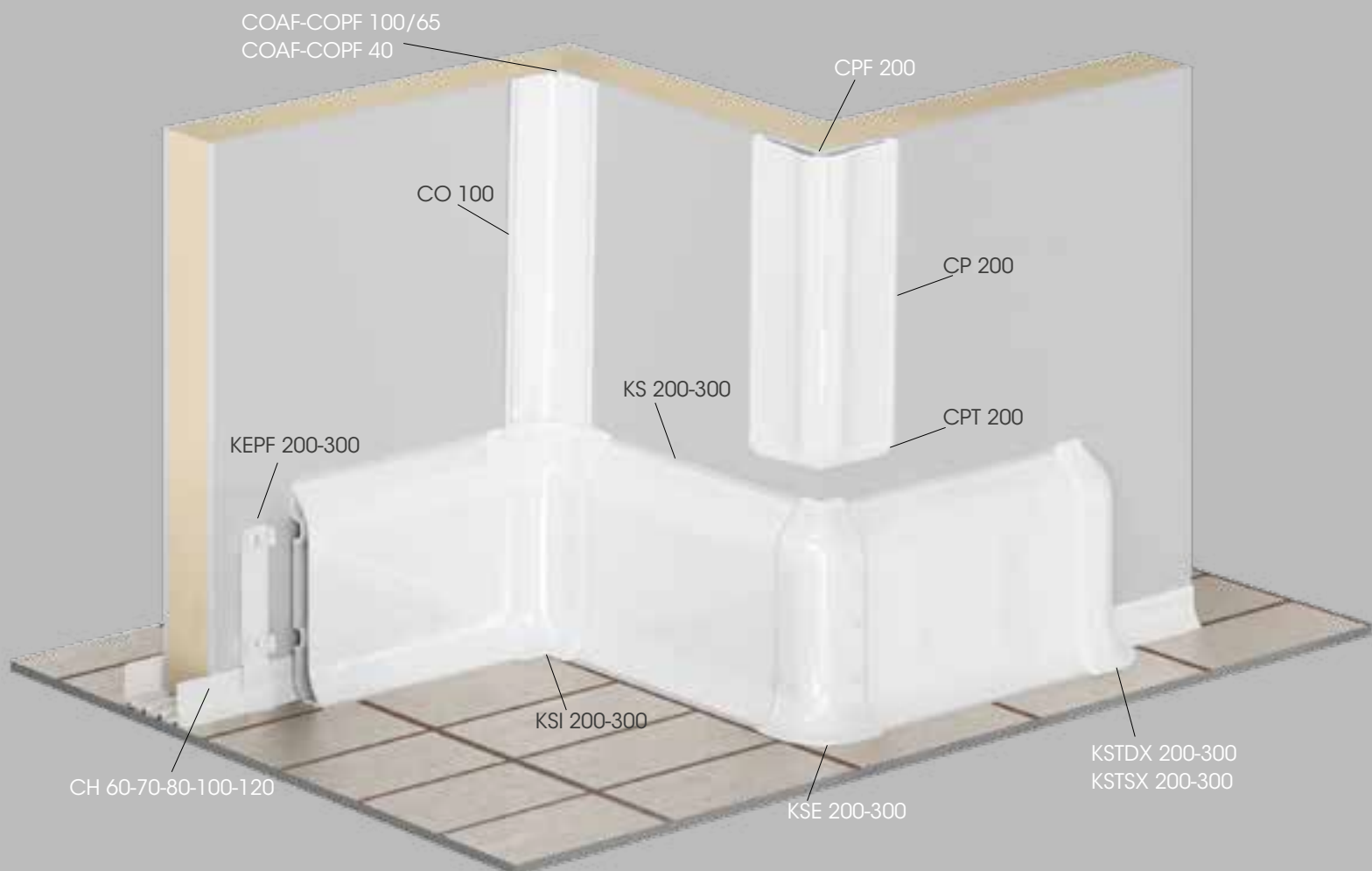

Kerb



KS 200

Length **4.000 mm**
 Packing **3 pz / box**
 Colour **B E M**

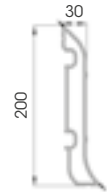

KEPF 200

To install with TB14

Packing **50 pz / box**
 Colour **K**

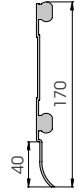

KSJ 200

To install with TB14 / TF14

Packing **20 pz / box**
 Colour **B E**

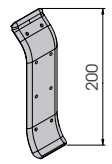

KSI 200

To install with TB14 / TF14

Packing **20 pz / box**
 Colour **B E**

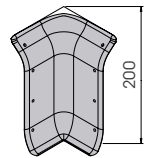

KSE 200

To install with TB14 / TF14

Packing **20 pz / box**
 Colour **B E**

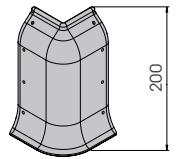

KSTDX 200 KSTSX 200

To install with TB14 / TF14

Packing **20 pz / box**
 Colour **B E**

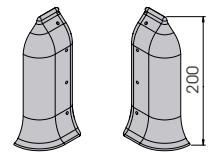

KSJ 200 LT

**THERMAL
BREAK
RESISTANT**

**FLEXIBLE
JOINT**

Packing **to be defined**
 Colour **K**

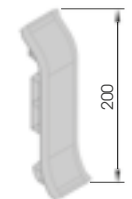

CP 200

Length **4.000 mm**
 Packing **2 pz / bag**
 Colour **B E M**



CPF 200

Length **4.000 mm**
 Packing **2 pz / bag**





CPT 200

Packing 20 pz / box
Colour B E

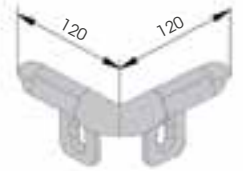

KS 300

Length 4.000 mm
Packing 1 pz
Colour E M

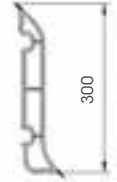

KEPF 300

To install with TB20

Packing 40 pz / box
Colour K

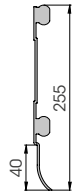

KSJ 300

To install with TB20 / TF20

Packing 10 pz / box
Colour B E

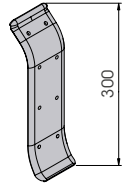

KSI 300

To install with TB20 / TF20

Packing 10 pz / box
Colour B E

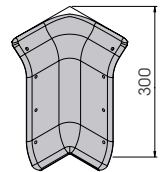

KSE 300

To install with TB20 / TF20

Packing 10 pz / box
Colour B E

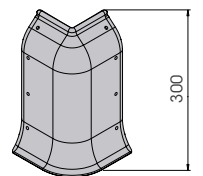

KSTDX 300

KSTSX 300

To install with TB20 / TF20

Packing 10 pz / box
Colour B E

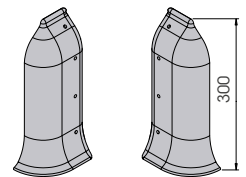

12

ANTISHOCK SYSTEM

New bumper and plinth system produced in soft material, could be used in cold rooms, refrigerated storages and garages. Thanks to material elasticity, it features good anti-shock property.

Nuova linea di paracolpi e battiscopa in materiale morbido per celle frigo, magazzini refrigerati, garage. Ottima proprietà anti-urto grazie all'elasticità del materiale utilizzato.

Nouvelle gamme de lisses de protection et plinthes en matière souple pour les chambres froides, depots et garages. Excellente propriété anti-choc grâce à l'élasticité du matériel utilisé.



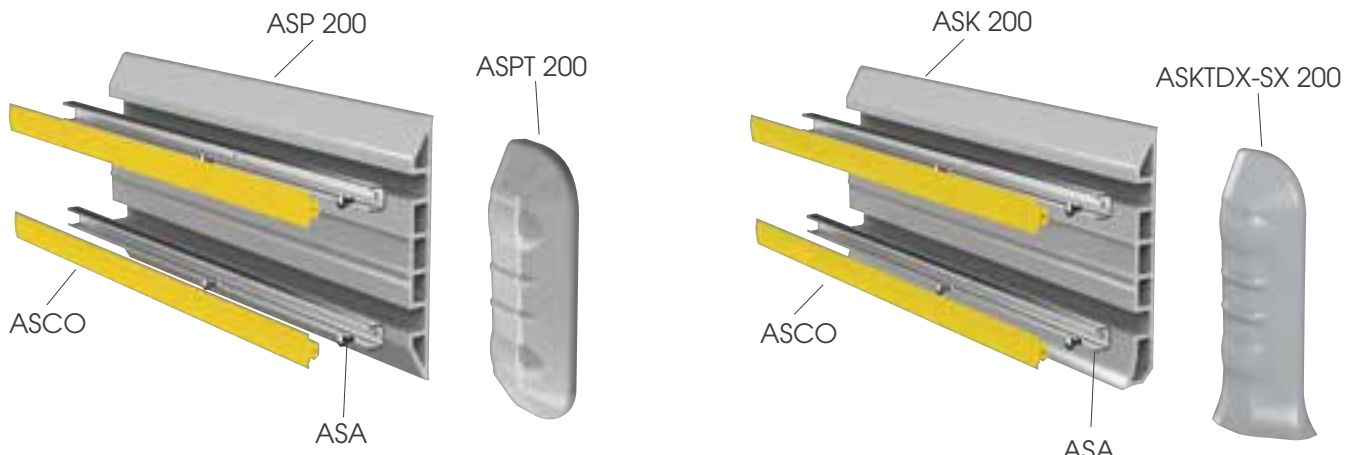

ASK 200



Packing **2 pz / box**
L = 4.000 mm
Colour **B M**

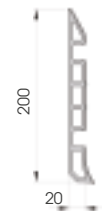

ASKTDX 200
ASKTSX 200



Packing **to be defined**
Colour **B**

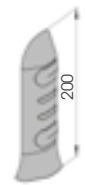

ASP 200



Packing **2 pz / box**
L = 4.000 mm
Colour **B M**



ASPT 200



Packing **10 pz / box**
Colour **B D**

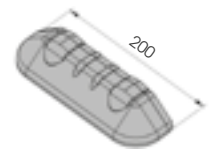

ASA

Material **aluminium**
Length **4.000 mm**
Packing **8 pz / bundle**



ASCO



Packing **2 pz / box**
L = 32.000 mm
Colour **A B D G M**



13 DOOR FRAME

Modular system which suits different sizes and thicknesses with the possibility to build corners welding or inserting fast connections. It's equipped with spaces for resistance and for additional supports to add during the assembly. It can be covered with plates.

Sistema modulare adeguabile a differenti spessori con possibilità di effettuare angoli a saldatura o con innesti rapidi. Provisto di passaggio per resistenza e di insenature per l'inserimento di rinforzi durante il montaggio degli accessori. Rivestibile con lamiera.

Système modulable qui s'adapte à différentes épaisseurs et dimensions, avec la possibilité de réaliser des angles à souder ou avec des connexions rapides. Equipé d'espaces pour le passage de résistances et de renforcements additionnels pour le montage des accessoires. Peut-être revêti des tôles.



ROUNDED VERSION

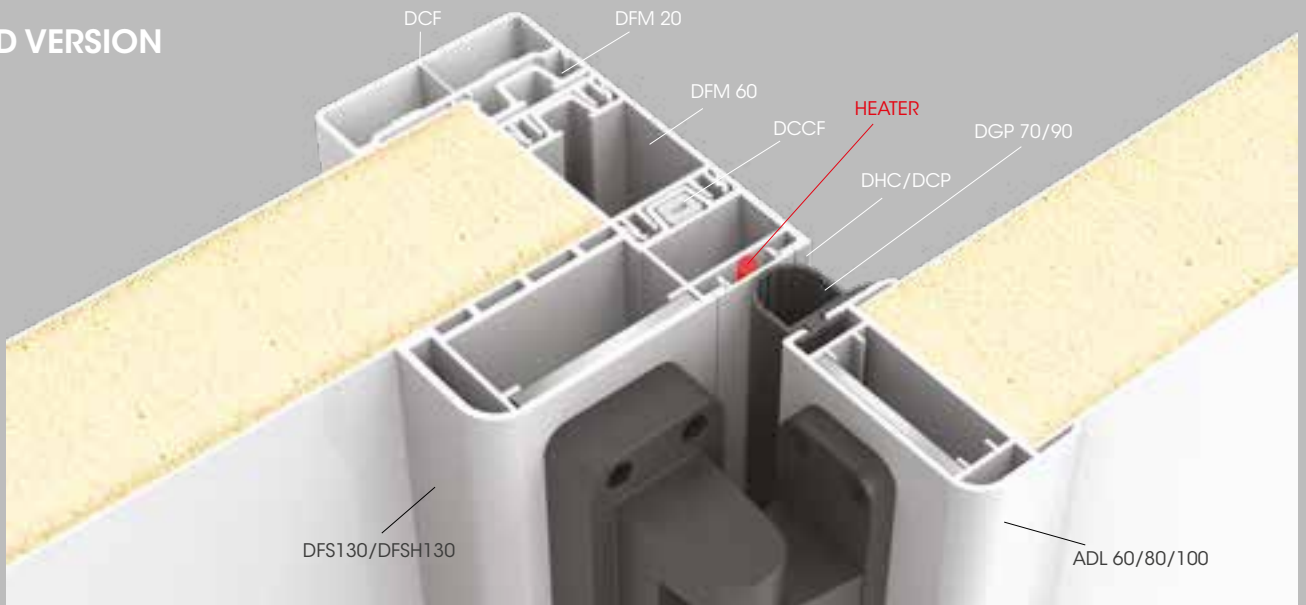

TRIS VERSION

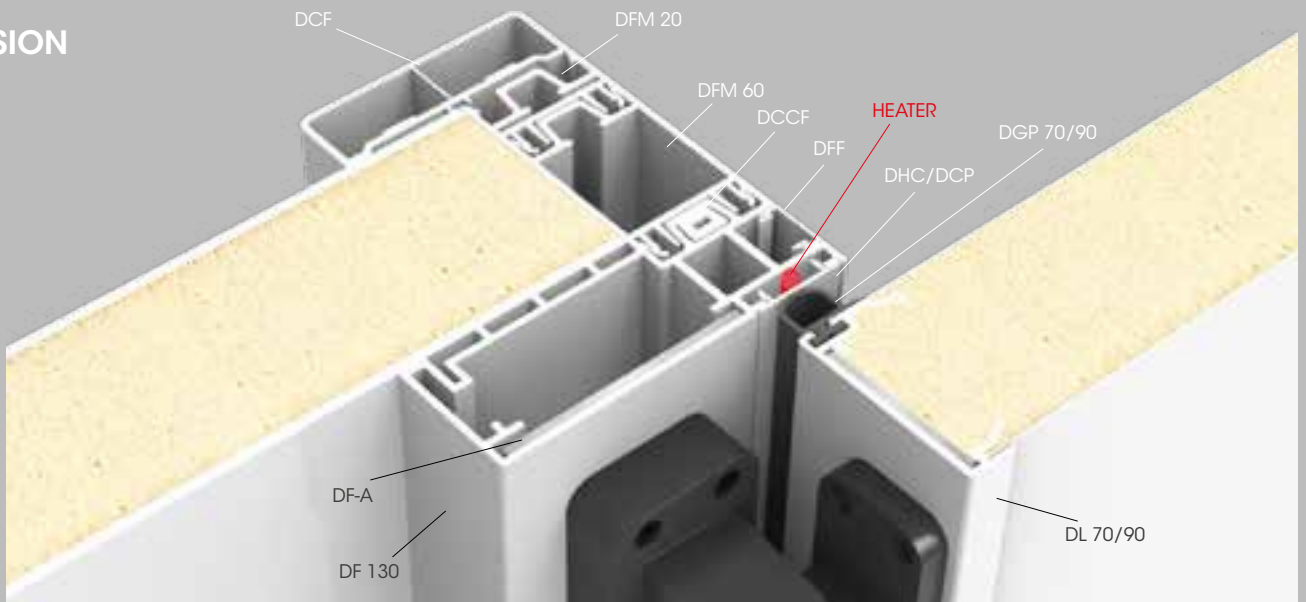

BIS VERSION

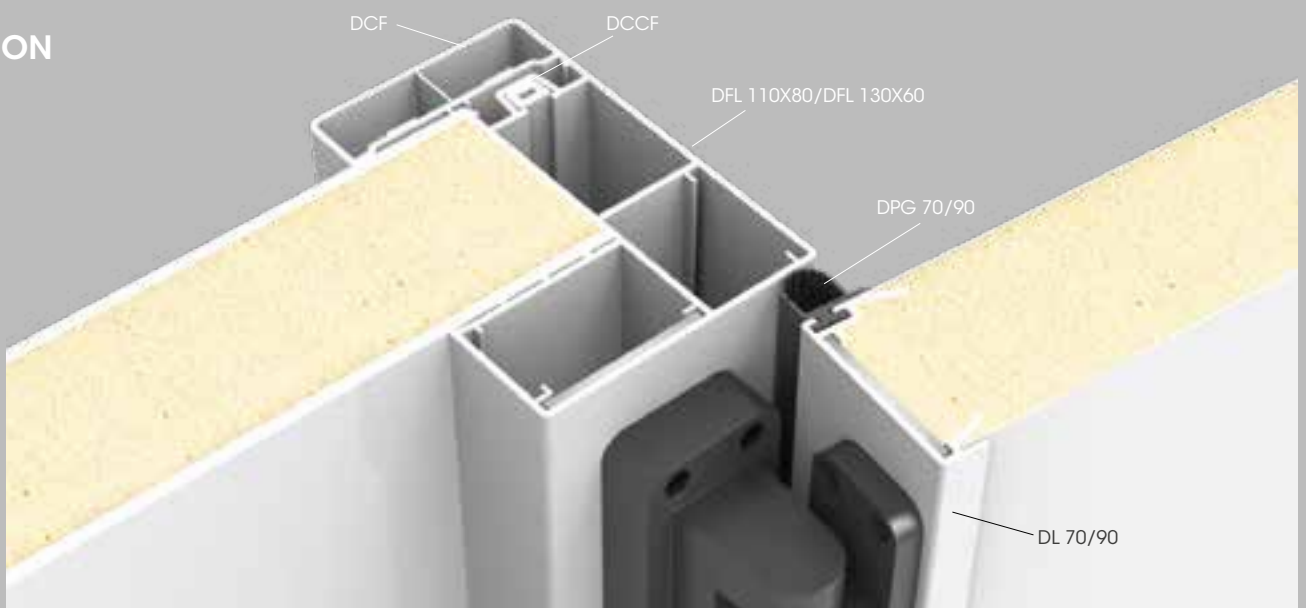

Door Frame

How to assemble DFS 130

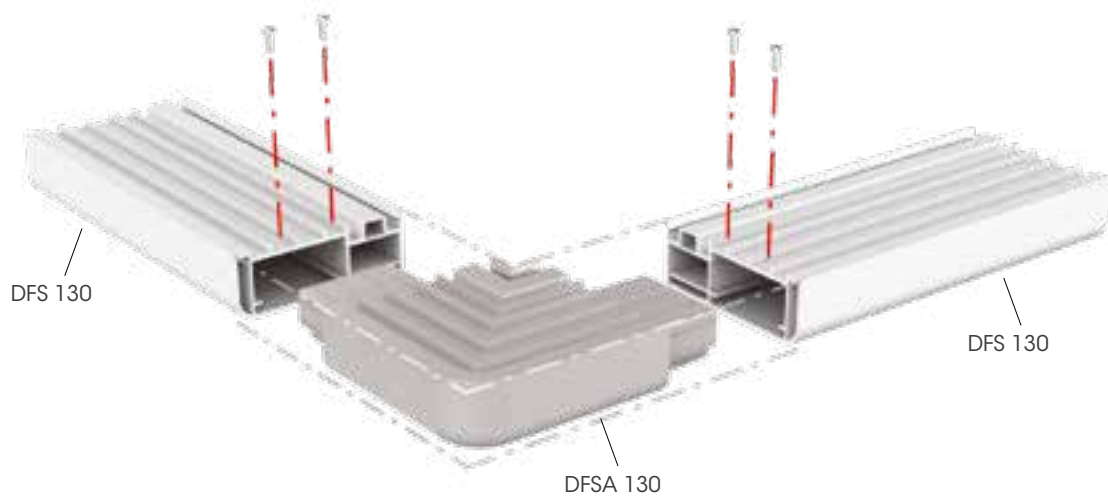

How to assemble DF 130

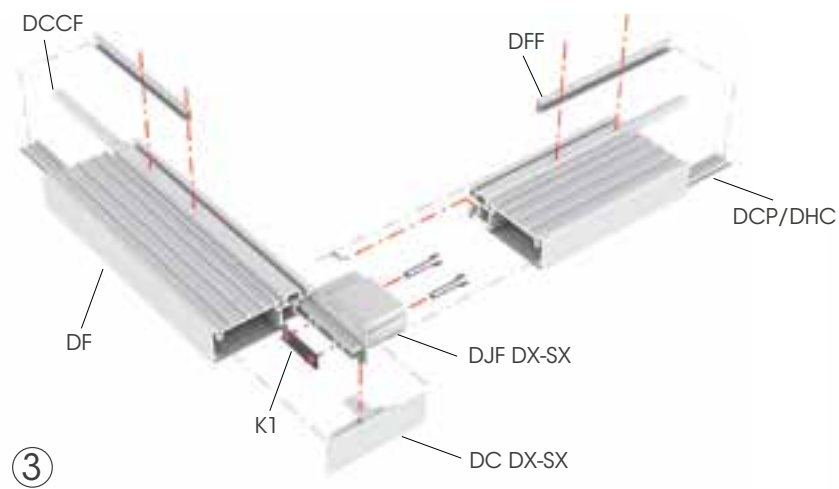
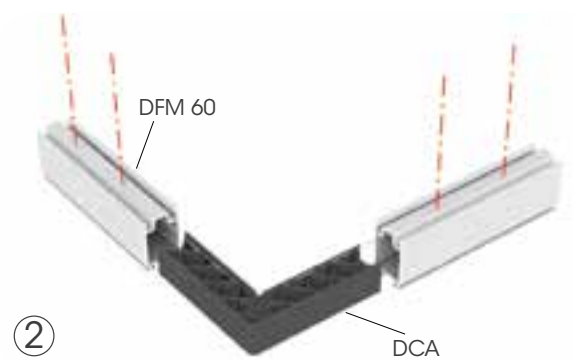
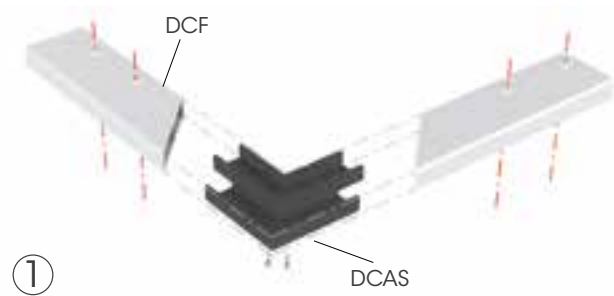

Door Frame



DFS 130

Length **5.800 mm**
 Packing **2 pz / bag**
 Colour **E**

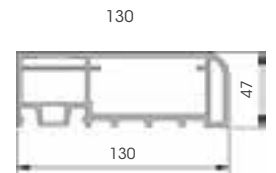

DFS H 130



Length **5.800 mm**
 Packing **2 pz / bag**
 Colour **E**

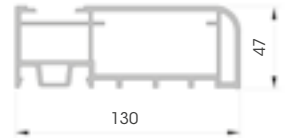

DFSA 130

Packing **12 pz / bag**
 Colour **K**

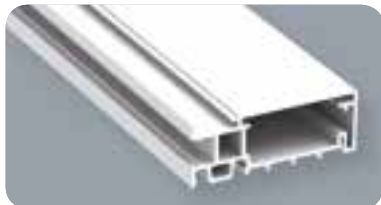
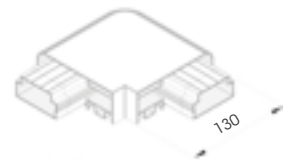

DF 130

Length **5.800 mm**
 Packing **2 pz / bag**
 Colour **E**

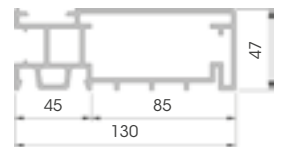

DF-A

Material **aluminium**
 Length **2.500 mm**
 Packing **2 pz / bundle**

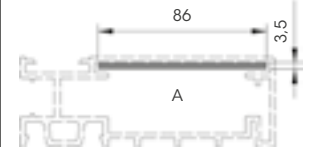

ADLC 60
ADLC 80
ADLC 100

Length **5.800 mm**
 Packing **2 pz / bag**
 Colour **E K**

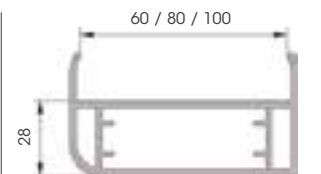

ADL H 60
ADL H 80
ADL H 100
 To install with AHC



Length **5.800 mm**
 Packing **2 pz / bag**
 Colour **E K**

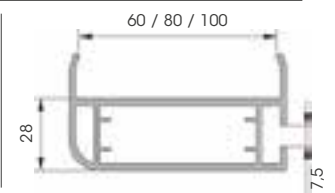

AHC

Material **aluminium**
 Length **5.800 mm**
 Packing **25 pz / bag**

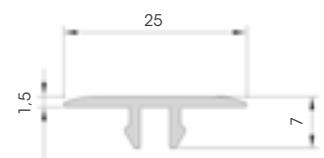

DFL 110x80

Length **5.800 mm**
 Packing **2 pz / bag**
 Colour **E**

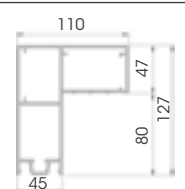

Door Frame



DFL 130x60



Length **5.800 mm**
 Packing **2 pz / bag**
 Colour **E**

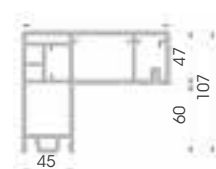

DFM 20

Length **5.800 mm**
 Packing **4 pz / bag**
 Colour **E**

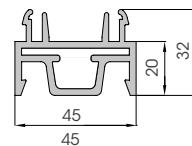

DFM 50

Length **5.800 mm**
 Packing **2 pz / bag**
 Colour **E**

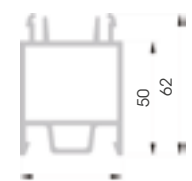

DFM 60

Length **5.800 mm**
 Packing **2 pz / bag**
 Colour **E**

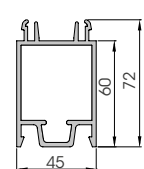

DFM 100

Length **5.800 mm**
 Packing **2 pz / bag**
 Colour **E**

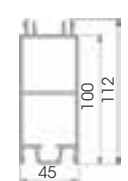

DCF

To install with TK 100 and TM 12

Length **5.800 mm**
 Packing **2 pz / bag**
 Colour **E**

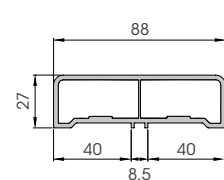

DCCF

Length **5.800 mm**
 Packing **25 pz / bag**
 Colour **various**

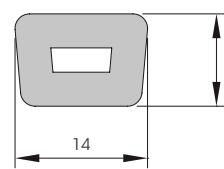

DFF

Length **5.800 mm**
 Packing **25 pz / bag**
 Colour **E**

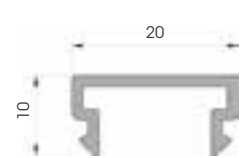

**DCP
 DHC**

Material **DCP plastic Ral 9010
 DHC aluminium**
 Length **5.800 mm**
 Packing **25 pz / bag**

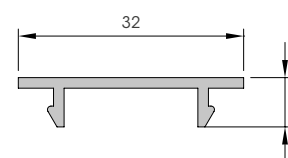

Door Frame



DJF DX
DJF SX

Packing 10 pz / box
Colour E



K1

Material galvanized steel
Packing 10 pz / bag

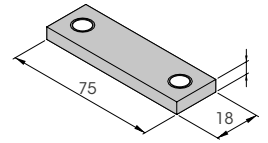

DC DX
DC SX

Packing 10 pz / box
Colour E

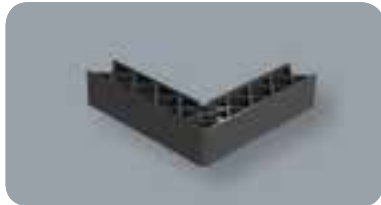

DCA

Packing 10 pz / box
Colour D

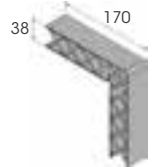

DCAS

Packing 20 pz / box
Colour D

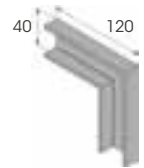

14 DOOR LEAF

Door profiles for continuous panels and foamed panels. Available in plastic to ensure thermal break.

Linea di profili porta per pannelli in continuo e schiumati. Disponibili in plastica per garantire l'isolamento termico.

Gamme de profilés pour portes frigorifiques à utiliser avec panneaux isolants réalisés par injection en continu de mousse polyuréthane. Ils sont disponibles en matière plastique pour garantir l'isolation thermique.



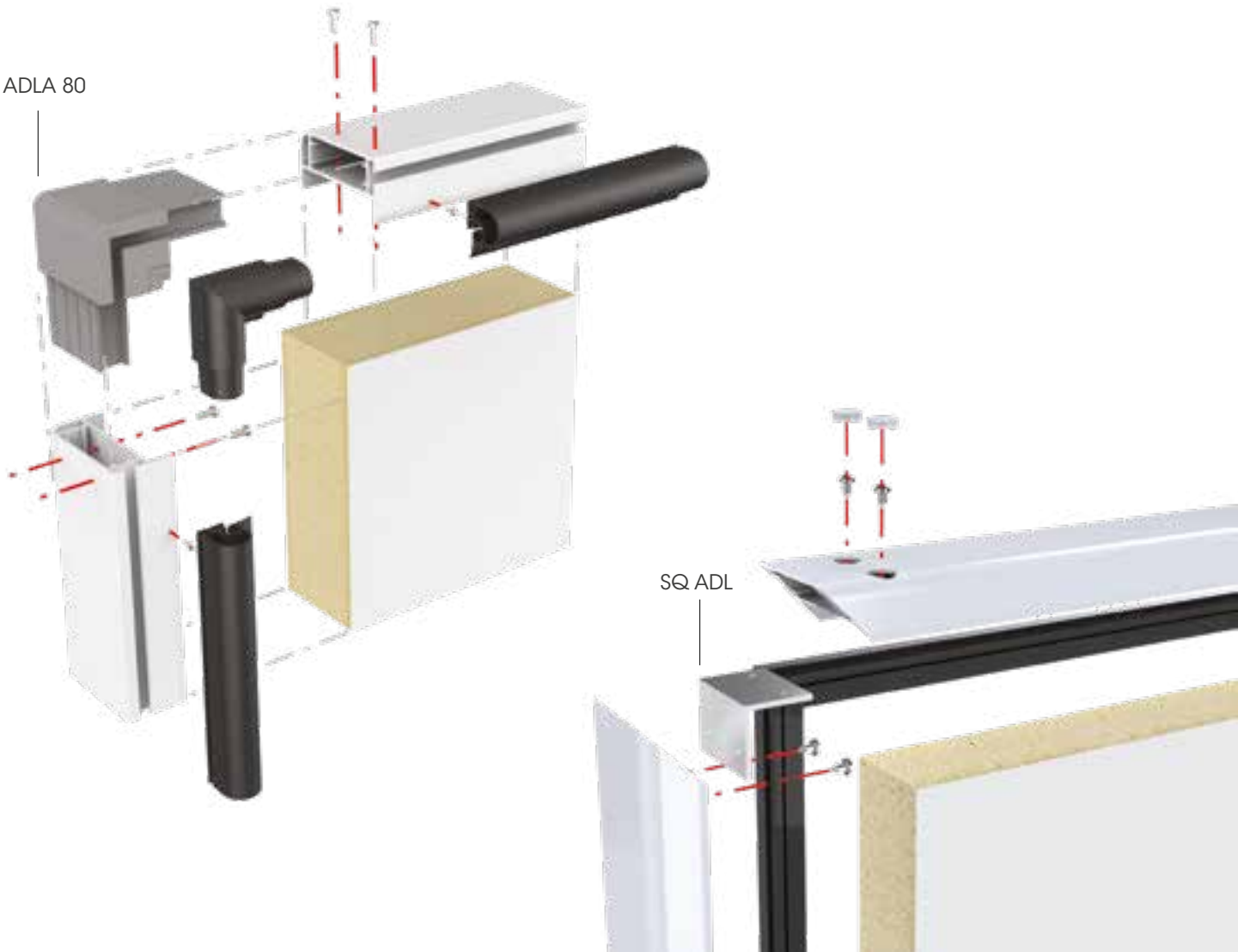
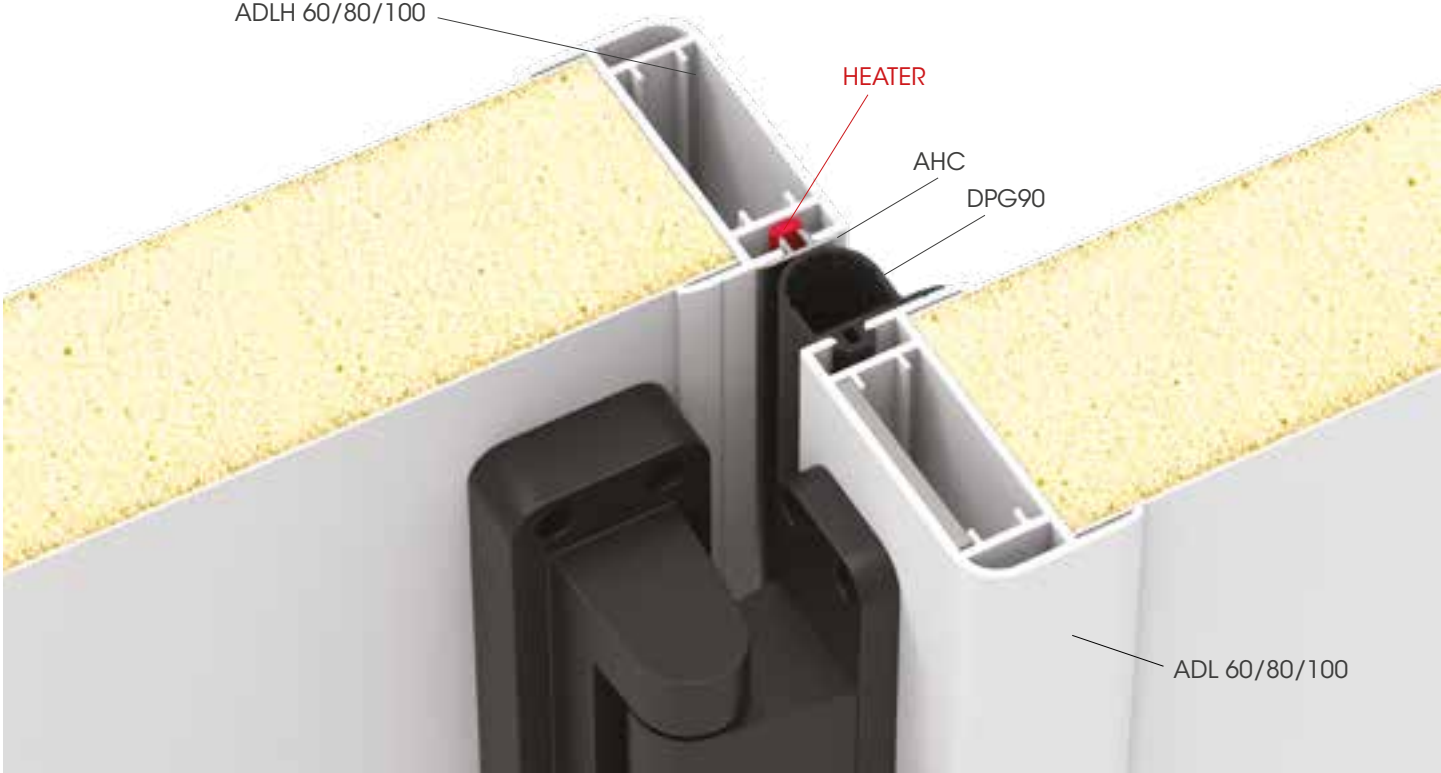

Door Leaf



ADL 60
ADL 80
ADL 100

To install with
TM 12 - DPG 90 - DPGW 90
DPGH 90 - DFG 90 - ADPG 90

Length **5.800 mm**
Packing **2 pz / bag**
Colour **E K**

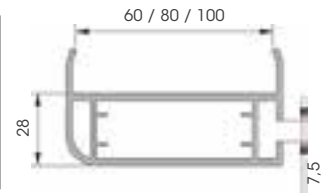

ADLA 60
ADLA 80
ADLA 100

Packing ADLA 60 **28 pz / box**
ADLA 80 **20 pz / box**
ADLA 100 **16 pz / box**
Colour **K**

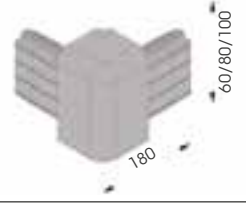

SQ ADL 60
SQ ADL 80
SQ ADL 100

Material **aluminium**
Packing **20 pz / box**

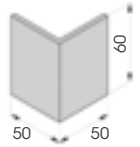

DL 70

Length **5.800 mm**
Packing **4 pz / box**
Colour **E K**

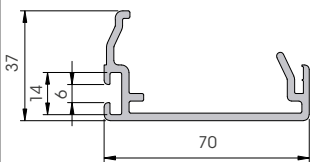

DL 90

Length **5.800 mm**
Packing **2 pz / bag**
Colour **E K**

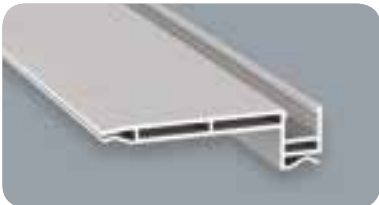
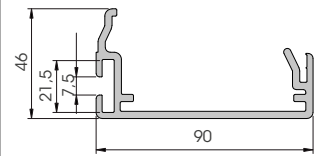

VANO 100
To install with VHC



Length **5.800 mm**
Packing **2 pz / bag**
Colour **E K**

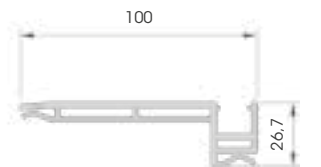

VHC

Length **5.800 mm**
Packing **24 pz / bag**
Colour **K**

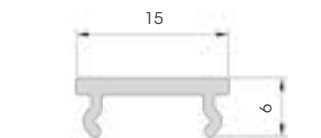

DW 60

Length **4.000 mm**
Packing **10 pz / bag**
Colour **E K**

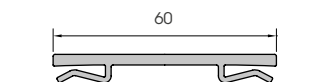

DW 70

Length **4.000 mm**
Packing **10 pz / bag**
Colour **E K**

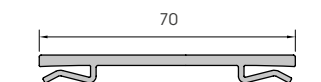



DW 80

Length **4.000 mm**
Packing **10 pz / bag**
Colour **E** **K**

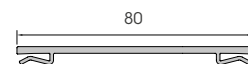

DW 100

Length **4.000 m m**
Packing **10 pz / bag**
Colour **E** **K**

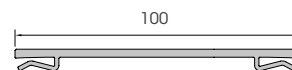

15 GASKETS

**NEW
CORNER
FOR
GASKETS**



Linea di guarnizioni porta facili da installare. Disponibili sia per basse temperature che per temperature normali.

Complete range of door gaskets. Easy to install and available for both negative and normal temperatures.

Complète gamme de joints du périmètre-porte. Facile à installer et disponible pour les températures négatives et positives.

Door Leaf



DPG 70

Packing 1 pz / reel
L 80.000mm
Colour **D**

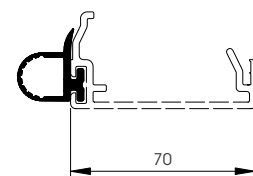

DPG W 70

Packing 1 pz / reel
L 80.000mm
Colour **D**

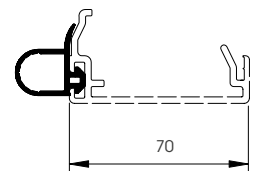

ADPG 70

To install with DPG 70
DPG W 70

Packing 50 pz / box
Colour **D**



DFG 70

Length 3.800 mm
Packing 12 pz / box
Colour **D**

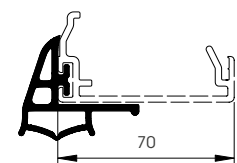

DPG 90

Packing 1 pz / reel
L 60.000 mm
Colour **D**

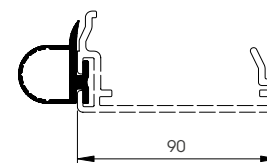

DPG W 90

Packing 1 pz / reel
L 60.000 mm
Colour **D**

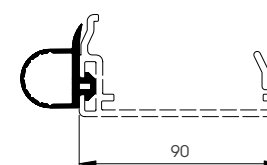

DPG H 90

Packing 1 pz / reel
L 60.000 mm
Colour **D**

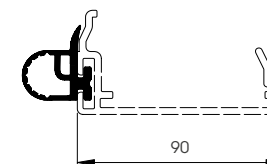

ADPG 90

To install with DPG 90
DPG W 90 - DPGH90

Packing 40 pz / box
Colour **D**

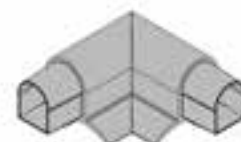

DFG 90

Length 3.800 mm
Packing 6 pz / box
Colour **D**

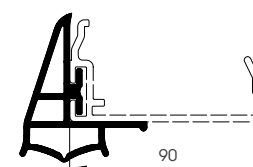



VELA

NOT FOR
STANDARD
GUIDES

Length **3.700 mm**
Packing **6 pz / box**
Colour **D**

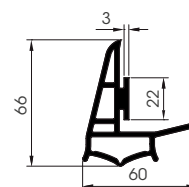

PLANE

NOT FOR
STANDARD
GUIDES

Length **4.000 mm**
Packing **15 pz / box**
Colour **D**

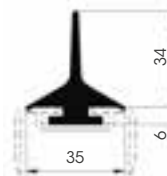

16

ACCESSORIES FOR PANEL



Profiles and moulded accessories to complete the panel finish. Practical for cleaning assuring good hygiene for the food industry.

Profilati e stampati per completare
la finitura di pannelli. Pratici per
la pulizia e l'igiene nel settore
alimentare.

Profilé et pièces injectés pour la
finition des panneaux. Utiles pour
assurer le nettoyage et l'hygiène
dans le domaine alimentaire.



**NEW
BREAKING
RESISTANCE
2.099 KG**



Accessories for panels



BAR 15

Breaking resistance with 660 Kg self-tapping screw \varnothing 6,3 mm



Length **on request**
Packing **boxes**
Colour **E**

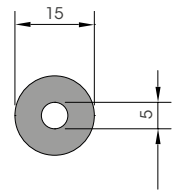

AC40

Breaking resistance for meter 4970 Kg



Length **4.000 mm**
Packing **4 pz / bundle**
Colour **E**

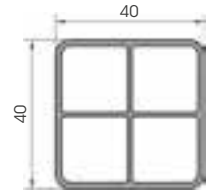

AC 70

Breaking resistance for meter 5000 Kg



Length **4.000 mm**
Packing **2 pz / bundle**
Colour **E**

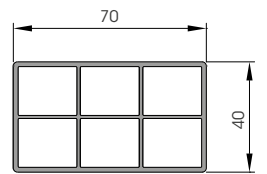

ACT 70

Packing **100 pz / box**
Colour **E**

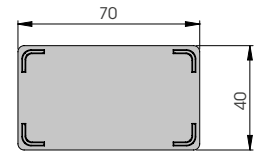

MC 50

Length **4.000 mm**
Packing **20 pz / box**
Colour **E**

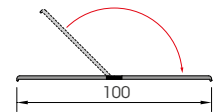

L 35x35

Length **4.000 mm**
Packing **40 pz / bundle**
Colour **E**

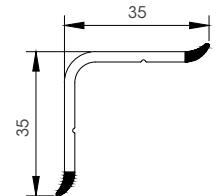

L 120x60

Length **4.000 mm**
Packing **4 pz / bundle**
Colour **E**

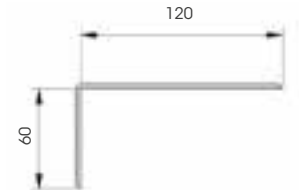

L 150x150

Length **4.000 mm**
Packing **2 pz / bundle**
Colour **E**

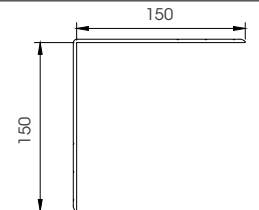

SH 40

Length **4.000 mm**
Packing **32 pz / box**
Colour **E**

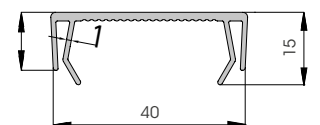



SH 60

Length **4.000 mm**
Packing **25 pz / box**
Colour **E**

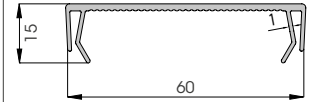

R 60

Packing **300 pz / box**
Colour **E F**

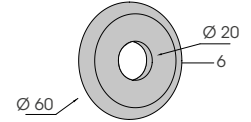

R 90

Available with hole \varnothing 14/20 mm

Packing **150 pz / box**
Colour **E F**

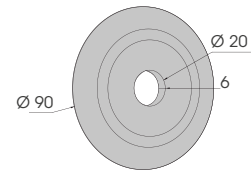

M 8 Medium breaking resistance 550 Kg
M 10 Medium breaking resistance 520 Kg
M 12 Medium breaking resistance 665 Kg

Packing **300 pz / box**
Colour **E F**

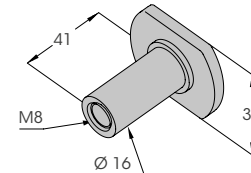

M 8H
M 10H
M 12H

Packing **300 pz / box**
Colour **E F**

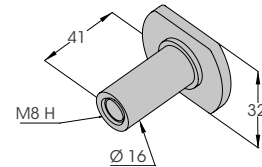

M 10 SI
Medium breaking resistance 2.099 Kg



Packing **300 pz / box**
Colour **E F**

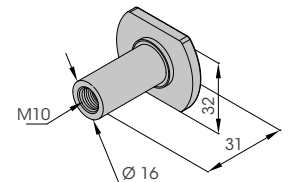

DAD 12

Packing **1.000 pz / box**
Colour **White**

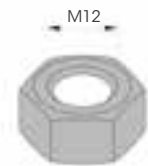

BAR 12

Length **500 mm**
Packing **100 pz / box**
Colour **White**

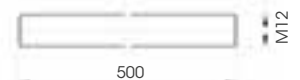

RON 12

Packing **1000 pz / box**
Colour **White**

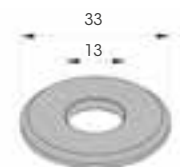

17 TRIMS

Complete range of profiles and accessories used to fix and to finish panels.

Gamma completa di profili e accessori per l'incastro e la finitura dei pannelli.

Gamme complète de profilés et d'accessoires pour le joint et la finition de panneaux.



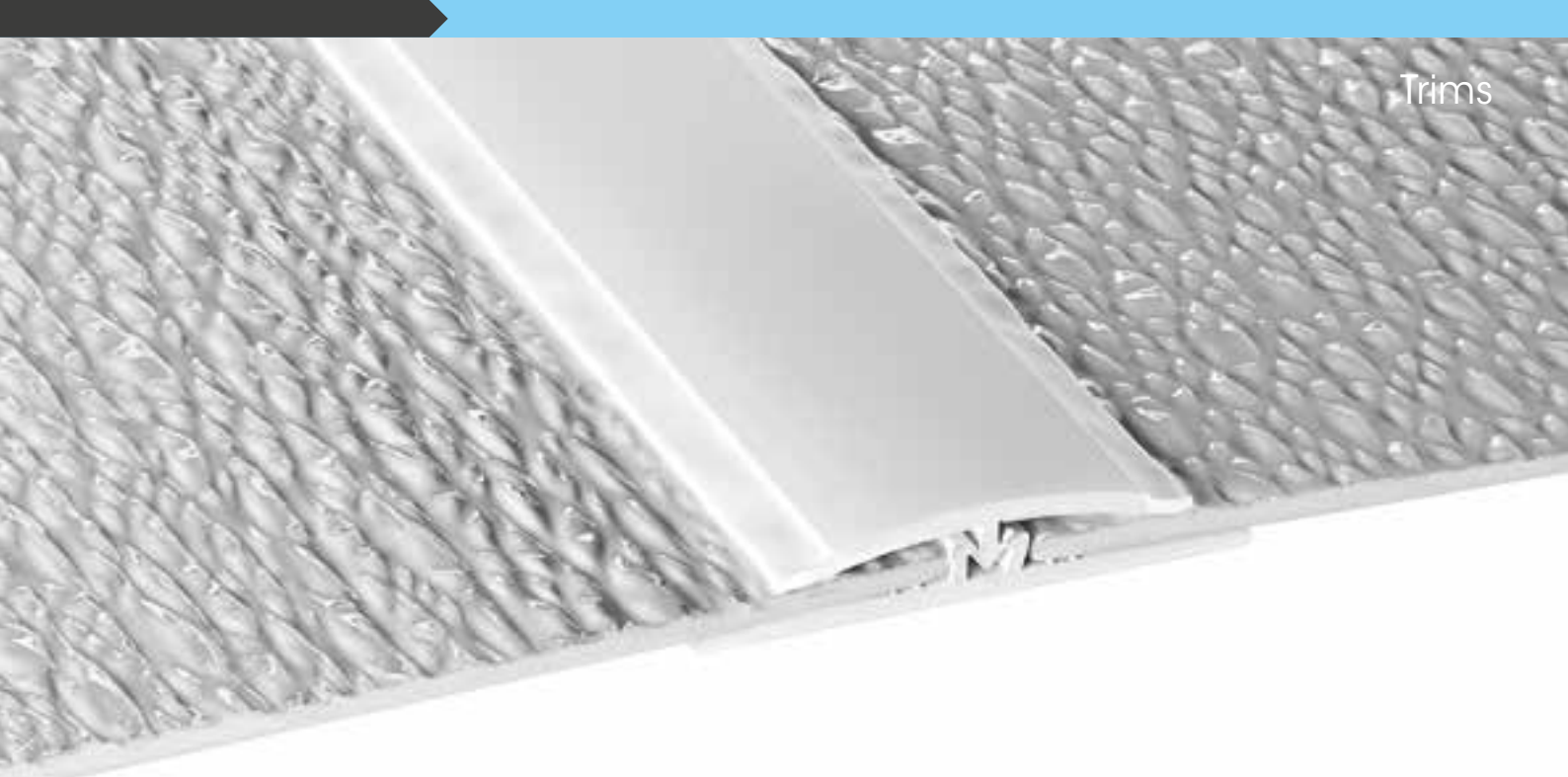

PCC

Length **2.500 / 3.000 mm**
 Packing **30 pz / box**
 Colour **E**

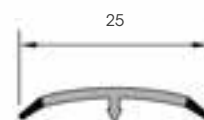

PCB

Length **2.500 / 3.000 mm**
 Packing **30 pz / box**
 Colour **White**

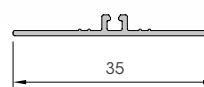

PCS

Length **2.500 / 3.000 mm**
 Packing **30 pz / box**
 Colour **E**

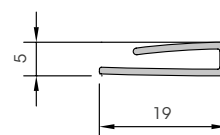

PDB

Length **2.500 / 3.000 mm**
 Packing **30 pz / box**
 Colour **E**

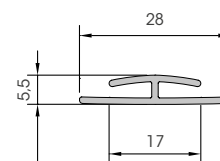

PCI

Length **2.500 / 3.000 mm**
 Packing **30 pz / box**
 Colour **E**

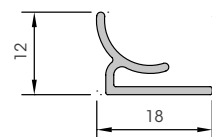

PCO

Length **2.500 / 3.000 mm**
 Packing **30 pz / box**
 Colour **E**

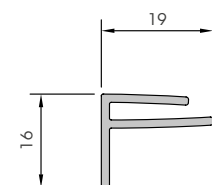

18

T SUSPENSION ALUMINIUM PROFILES

**CERTIFICATED
BREAKING RESISTANCE**



T and Omega profiles for ceiling suspension. White painted aluminium profiles, fire resistance and equipped with stainless steel nuts covered in plastic to ensure thermal bridge. Two solutions available, one light and one heavy.

Profili a T e Omega per soffitto a sospensione. Realizzati in alluminio verniciato bianco, resistenti al fuoco e provvisti di dadi in acciaio ricoperti in plastica che fungono da taglio termico. Disponibili 2 soluzioni, una leggera e una pesante.

T et Omega profilés pour la suspension de plafond. Blanc laqué profilés en aluminium, résistants au feu et équipés d'écrous en acier inox recouverts de plastique pour garantir le pont thermique. Deux solutions disponibles, une légère et une lourde.



T Suspension



T 85



Length **4.000 mm**
 Packing **2 pz / bundle**
 Colour **E F**

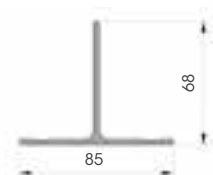

T 130



Length **4.000 mm**
 Packing **2 pz / bundle**
 Colour **E F**

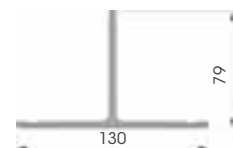

OME 110



Length **4.000 mm**
 Packing **5 pz / bundle**
 Colour **E F**



OME 150



Length **4.000 mm**
 Packing **2 pz / bundle**
 Colour **E F**



CEBES 100



Length **4.000 mm**
 Packing **5 pz / bundle**
 Colour **E F**



CEBES 130



Length **4.000 mm**
 Packing **3 pz / bundle**
 Colour **E F**



OMES S



Packing **75 pz / box**
 Colour **E**

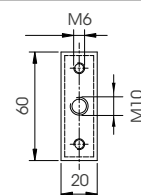

OMES L



Packing **50 pz / box**
 Colour **E**

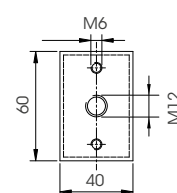

SJ8
SJ10
SJ12

Material **galvanized steel**
 Packing **50 pz / box**

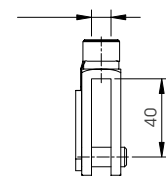

19

BUMPER 30

Small bumper to be used on refrigerated cabinets and check-outs, easy set up for installing profiles on pvc guide, available in soft or rigid pvc.

Paracolpi di piccole dimensioni ideale per vetrine refrigerate e check outs, facile da installare con rapido fissaggio tramite incastro su guida in pvc, disponibile in materiale rigido o morbido.

Profilé anti-choc de petites dimensions idéal pour les vitrines réfrigérées et les compteurs, facile à installer avec fixation rapide par le support en pvc disponible en matériel dur ou souple.



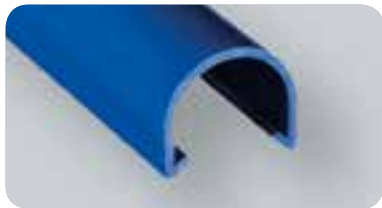
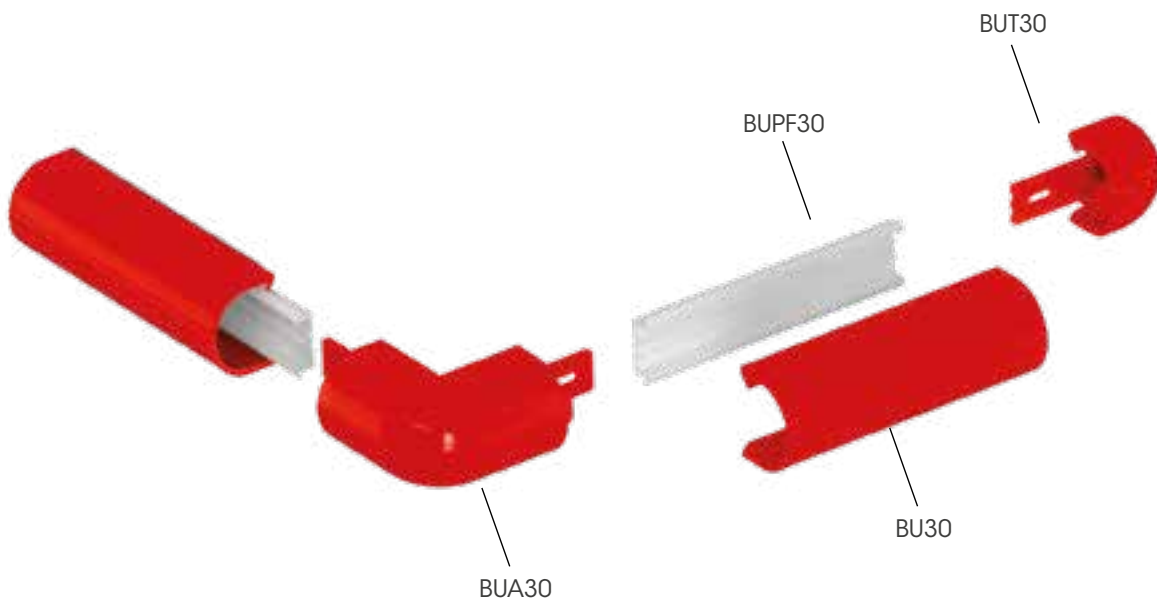

BU 30

Length **4.000 mm**
Packing **22 pz / box**
Colour

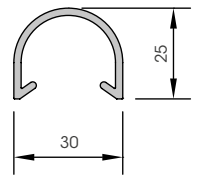

BU 30 flex

Minimum radius: 60 mm

Packing **2 pz / box**
L = **22.000 mm**

Colour

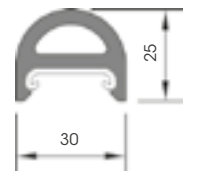

BUPF 30

Length **4.000 mm**
Packing **22 pz / box**

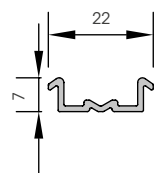

BUT 30

Packing **100 pz / box**
Colour

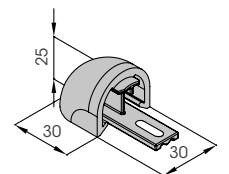

BUA 30

Packing **50 pz / box**
Colour

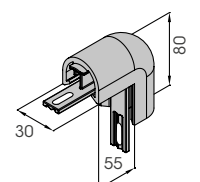

20 BUMPER 50

Highly resistant against impacts, linear but functional design, high resistant, easy to install and equipped with accessories.

Profilo paracolpi dal design semplice e funzionale. Resistente, facile da installare e completo di accessori.

Profilé anti-choc avec un design simple et fonctionel. Résistant, facile à installer et fourni entièrement équipé.



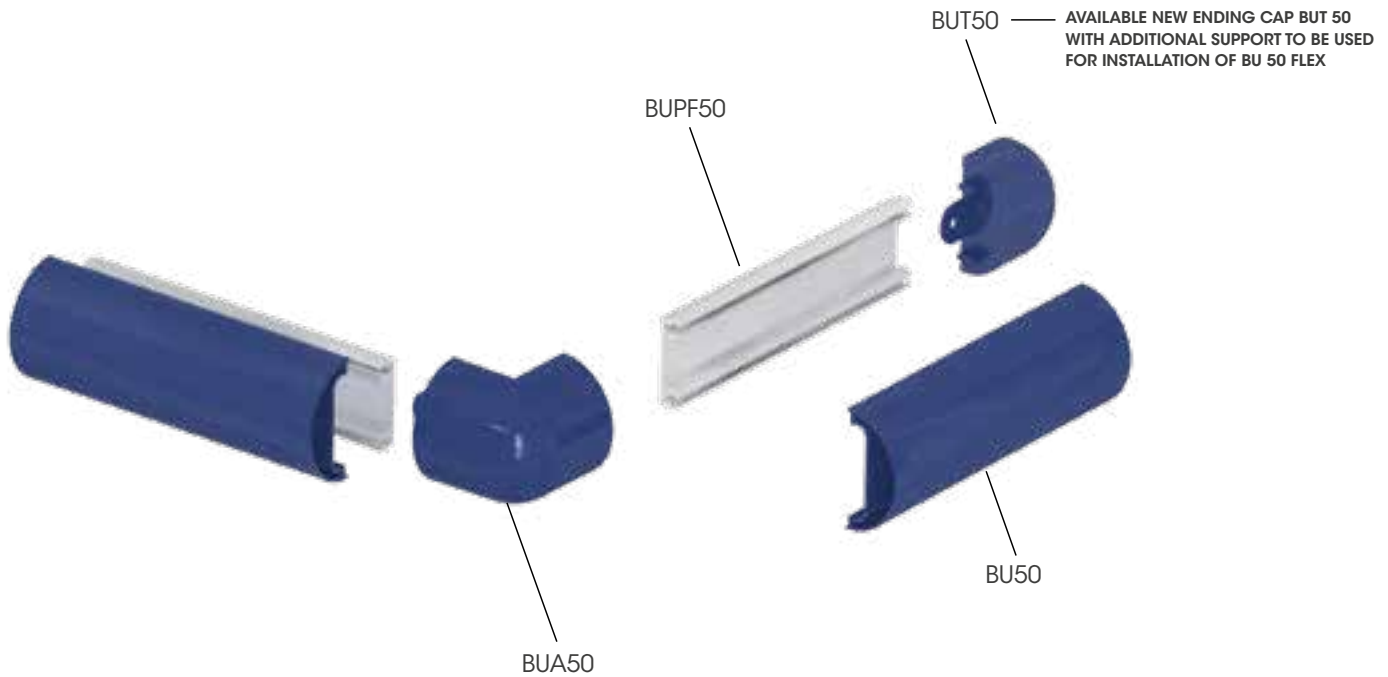

BU 50

Length **4.000 mm**
Packing **14 pz / box**
Colour

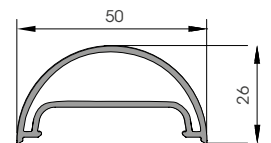

BU 50 flex

Minimum radius: 250 mm

Length **4.000 mm**
Packing **14 pz / box**
Colour

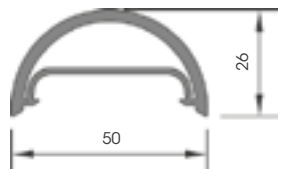

BUPF 50

Length **4.000 mm**
Packing **14 pz / box**

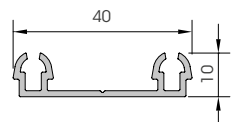

BUT 50

Packing **50 pz / box**
Colour



BUA 50

Packing **50 pz / box**
Colour

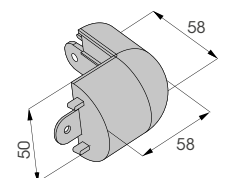

21 BUMPER 80

Without guides, this profile is directly fixed to the wall through hidden screws covered by a specific item available in various colours.

Articolo paracolpi a fissaggio diretto alla parete tramite viti nascoste da un apposito profilo disponibile in vari colori.

Profilé anti-choc à fixation directe aux murs grâce à des vis cachées par un profilé disponible en plusieurs couleurs.



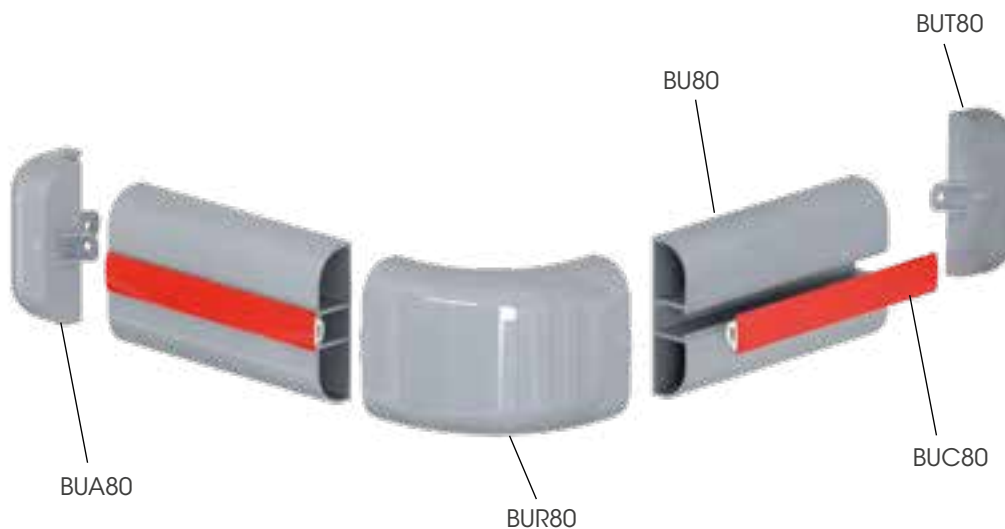

BU 80

Length **4.000 mm**
Packing **6 pz / box**
Colour **B N**

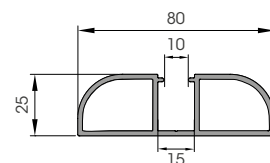

BUC 80

Length **60 mt / reel**
Packing **cardboard reel**
Colour **A B M D G H N**

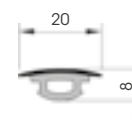

BUT 80

Packing **50 pz / box**
Colour **B N**

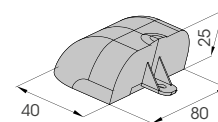

BUA 80

Packing **50 pz / box**
Colour **B N**

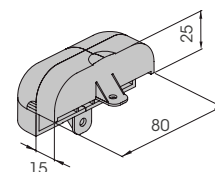

BUR 80

Packing **25 pz / box**
Colour **B N**

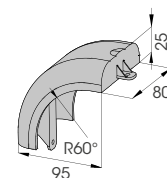

22

BEND 80

Unique in range and shape,
a forceful choice between
convenience and stylish design.
Corner caps are not necessary.

Articolo unico nel suo genere,
compromesso tra praticità
e design elegante. Si adatta alla
parete senza l'ausilio di raccordi.

Article unique en son genre,
parfait compromis entre la praticité
et le design élégant. Il s'adapte
au mur sans avoir besoin d'embouts
supplémentaires.

**PATENTED
BREVETTATO**



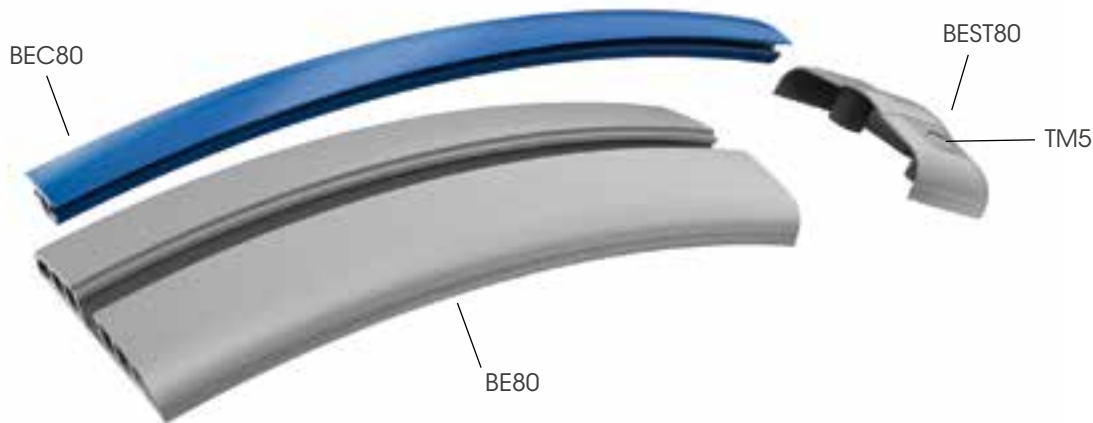

BES 80
With double-sided tape
Minimum radius: 40 mm

Packing **1 pz / box**
L= 25.000 mm
Colour **I**
+ colored strip
A G I

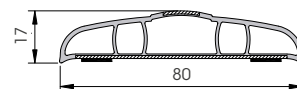

BED 80 with tape
BE 80 with screws
Minimum radius: 40 mm
To install with **BEC 80**

Packing **1 pz / box**
L = 25.000 mm
Colour **I**

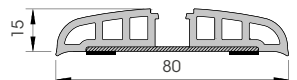

BER 80
To install with **BERCO 80**

Length **4.000 mm**
Packing **12 pz / box**
Colour **B K**



BEC 80

Length **60 mt / reel**
Packing **cardboard reel**
Colour **A B E G I**

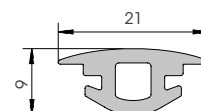

BERCO 80

Length **60 mt / reel**
Packing **cardboard reel**
Colour **A B M D E F G H I K**

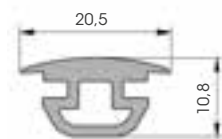

BEST 80
To install with **TM5**

Packing **50 pz / box**
Colour **B I K**

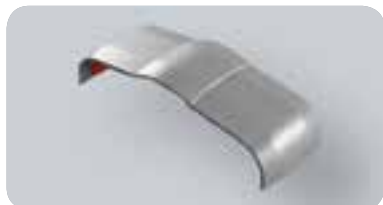
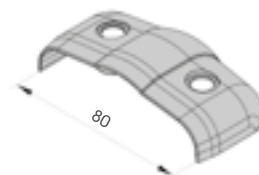

BEJ 80
With double- sided tape

Packing **50 pz / box**
Colour **I**

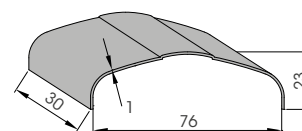

23

BUMPER SUPERFLEX 80

New flexible model of classic BU80, produced in coextruded material, features versatility and elegance, easy to install and shockproof.

Nuovissima versione del classico BU 80, prodotto in materiale coestruso, coniuga versatilità ed eleganza alle immancabili doti tecniche quali facilità di montaggio e resistenza all'urto.

Nouvelle version de classique BU80, produit en matériel co-extrudé, mélange polyvalence et élégance aux caractéristiques techniques tels que la facilité à l'assemblage et la résistance aux chocs.



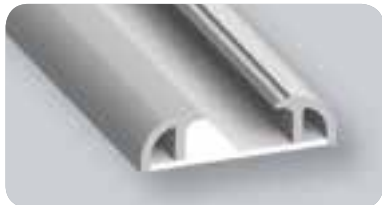
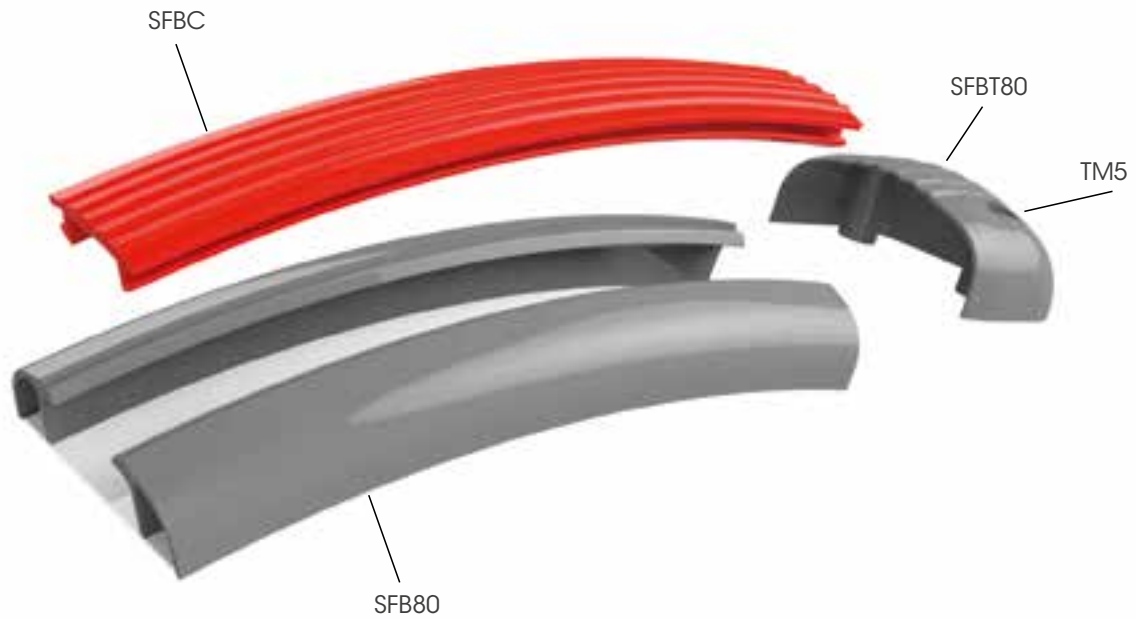

SFB 80

Packing **1 pz / box**
L = 10.000 mm

Colour **I**

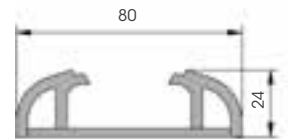

SFRB 80

Length **4.000 mm**
Packing **5 pz / box**
Colour **B**



SFBC

Packing **2 pz / box**
L = 40.000 mm

Colour **A** **E** **I**

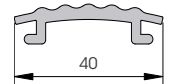

SFBT80

To install with TM5

Packing **50 pz / box**

Colour **B** **I**

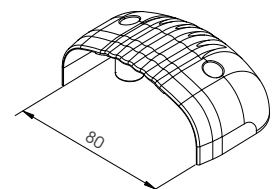

24

BUMPER MODULAR

New modular antischock profile with hidden screws. You can enlarge the protecting surface by adding simple profiles, economic and easy to clean.

Nuovo profilo paracolpi modulare con viti a scomparsa. Possibilità di aumentare la superficie di protezione con l'aggiunta di semplici profili, economico e facile da pulire.

Nouveau profilé modulable anti-choc avec attaches cachées. Vous pouvez élargir le profilé et la surface protégée en ajoutant simplement des profilés, économique et facile à nettoyer.



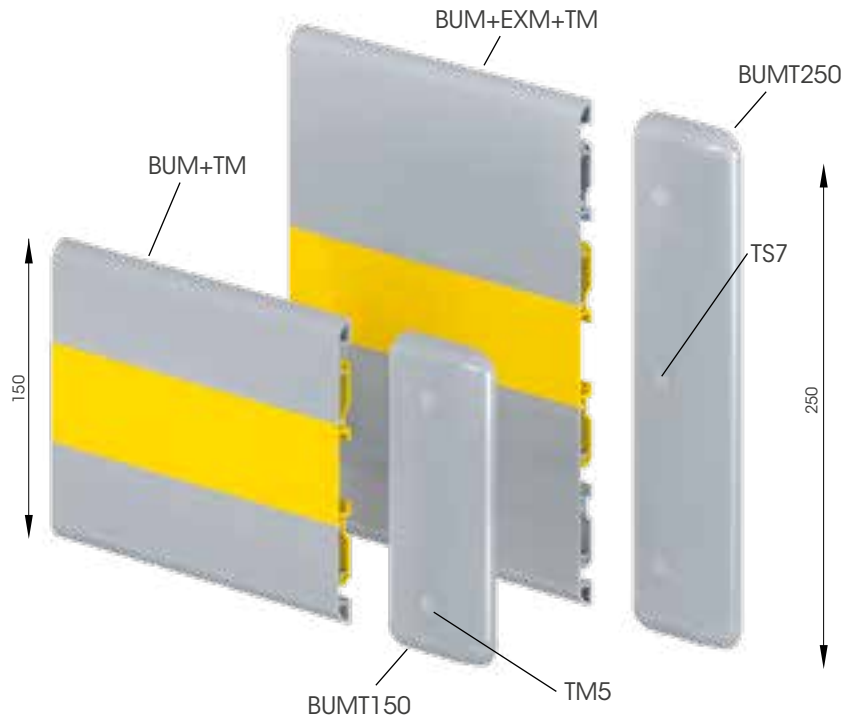

BUM

Length **4.000 mm**
Packing **8 pz / box**
Colour

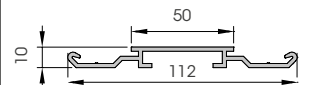

TM

Length **4.000 mm**
Packing **40 pz / box**
Colour

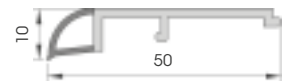

EXM

Length **4.000 mm**
Packing **20 pz / box**
Colour

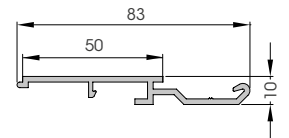

BUMT 150

To install with TM5

Packing **50 pz / box**
Colour

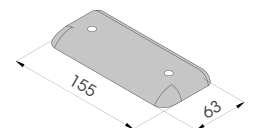

BUMT 250

To install with TS7

Packing **25 pz / box**
Colour

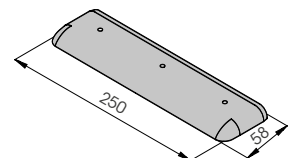

25 WALL PROTECTION



New bumper without guides. Thanks to its big size and resistance it is ideal for protection of industrial spaces. Fixed caps with hidden screws covered by specific buttons.

Nuovo profilo antiurto senza guida. La sua ampiezza e resistenza lo rende ideale per la protezione di ambienti industriali. Terminali fissati con viti nascoste da appositi bottoni.

Nouveau profilé anti-choc sans besoin d'une base à fixer. Sa mesure large et sa résistance en font le profilé parfait pour la protection des espaces industriels. Embouts fixés avec des vis cachées grâce à des bouchons spécifiques.





WP 100

Length **4.000 mm**
 Packing **8 pz / box**
 Colour **B E F**

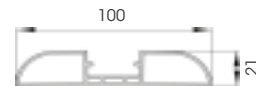

WP 150

Length **4.000 mm**
 Packing **4 pz / box**
 Colour **B E M**

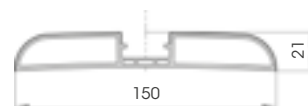

WPC

To install with WP 100 / WP 150

Length **4.000 mm**
 Packing **16 pz / box**
 Colour **A B D E F G H M**





WPT 100
To install with TM5

Packing 50 pz / box
Colour B E F

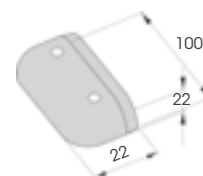

WPA 100
To install with TS9

Packing 20 pz / box
Colour B E

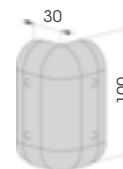

WPT 150
To install with TM5

Packing 50 pz / box
Colour B E

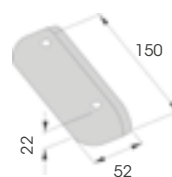

WPA 150
To install with TS9

Packing 20 pz / box
Colour B E



WPCS
To install with WP 100 / WP 150

Length 4.000 mm
Packing 8 pz / box
Colour A B M D E
F G H I

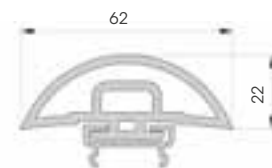

WPTS 100
To install with TS9

Packing 20 pz / box
Colour B E

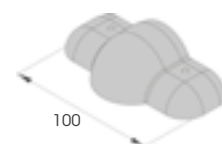

WPAS 100
To install with TS9

Packing 20 pz / box
Colour B E

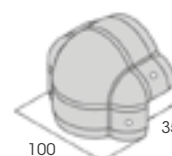

WPTS 150
To install with TS9

Packing 20 pz / box
Colour B E

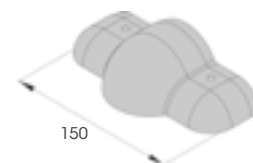

WPAS 150
To install with TS9

Packing 20 pz / box
Colour B E

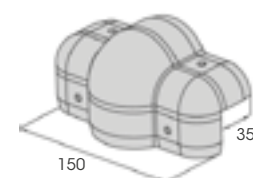

26

BUMPER 150

Soft but strong material.
Innovative and simple design.

Profilo antiurto in materiale morbido
ma indistruttibile. Design semplice
e versatile.

Profilé anti-choc réalisé avec un matériel
souple et rigide indestructible.
Design simple et innovant.



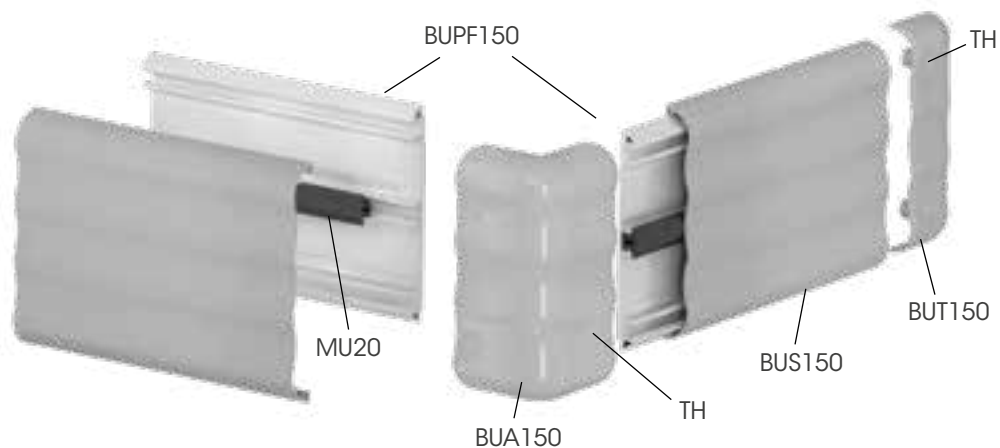

BU 150

Packing **1 pz / box**
L = 25.000 mm

Colour **I L**

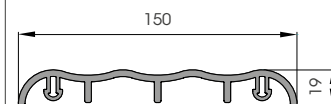

BUS 150

Length **4.000 mm**

Packing **6 pz / box**

Colour **B**

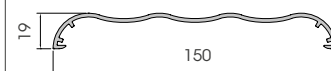

MU 20

Packing **1 pz / box**
L = 48.000 mm

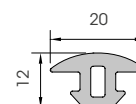

BUPF 150

Length **4.000 mm**
Packing **6 pz / bag**

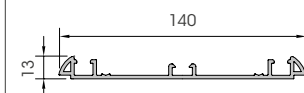

BUT 150

To install with TH

Packing **50 pz / box**

Colour **B I L**

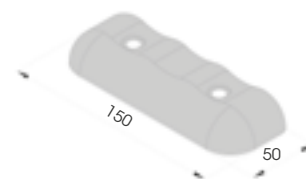

BUA 150

To install with TH

Packing **20 pz / box**

Colour **B I L**

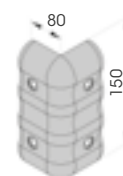

27

BUMPER FLOOR

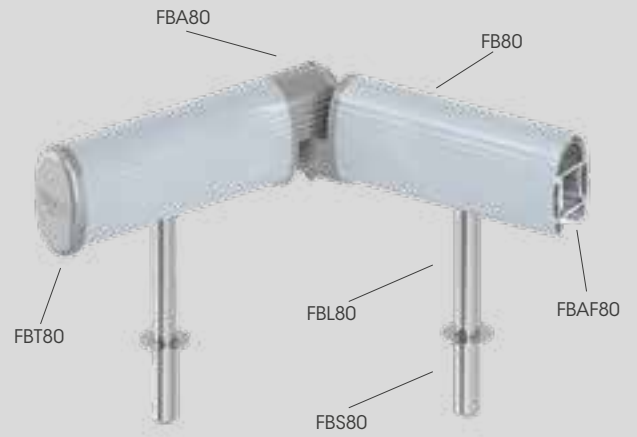

Spacer floor bumper to protect refrigerated cabinets and walls, fully equipped with corners and accessories necessary to assemble it.

Sistema di protezione distanziale a terra di banchi frigo e pareti, completo di curve e provvisto di accessori.

Système de protection au sol, épaisseur pour les vitrines réfrigérées et murs, pleine de courbes et équipé d'accessoires.



Bumper Floor



FB 80



Length **4.000 mm**
 Packing **6 pz / box**
 Colour **B**

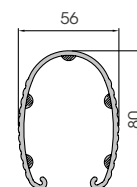

FBAF 80

Material **aluminium**
 Length **4.000 mm**
 Packing **6 pz / box**

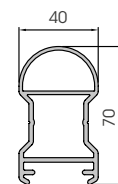

FBT 80

Equipped with screws

Material **aluminium**
 Packing **40 pz / box**



FBA 80

Equipped with screws

Material **aluminium**
 Packing **8 pz / box**

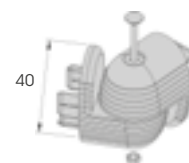

FBL 80

Equipped with screws

Material **stainless steel**
 Packing **20 pz / box**

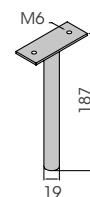

FBS 80

Material **stainless steel**
 Packing **20 pz / box**

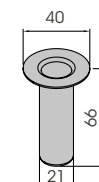

FR

Material **chemical anchor**
 Packing **1 pz / box**



FBR

Material **steel**
 Length **400 mm**
 Packing **to be defined**

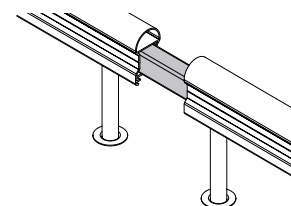

28 WHEEL SYSTEM

Complete system for sliding glass doors of refrigerated displays. Shockproof pvc profiles equipped with accessories to ensure a good insulation and consequently a considerable energy saving. A lower rail is installed to allow the easy sliding opening and closing of doors.

Sistema completo per le porte scorrevoli a vetro degli armadi a muro. Profili realizzati in pvc antiurto completi di accessori che assicurano un buon isolamento e di conseguenza un notevole risparmio energetico. Dotato di sistema di scorrimento che rende agevole l'apertura e la chiusura delle porte.

Système complet pour les portes coulissantes en vitre de vitrines réfrigérées. Profilés en pvc antichoc équipés d'accessoires pour assurer une bonne isolation et donc une économie d'énergie considérable. A rail inférieur est installé pour permettre le coulisement pratique de l'ouverture et de la fermeture des portes.

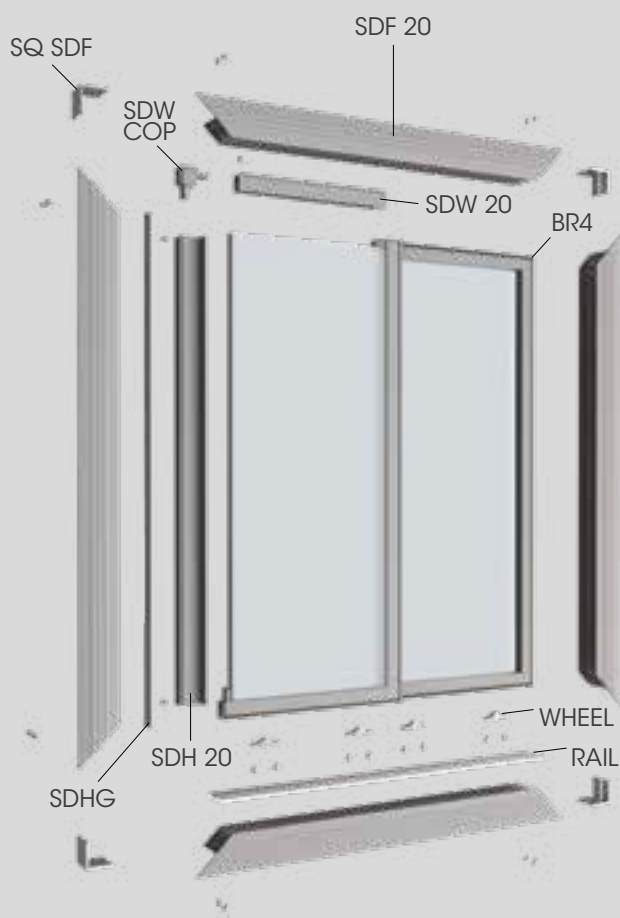



SDF 20

Length **4.000 mm**
 Packing **5 pz / box**
 Colour **B D**

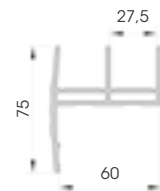

SDF 20 SHORT

Length **4.000 mm**
 Packing **5 pz / box**
 Colour **B D**

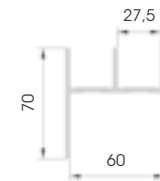

SDW 20

Length **4.000 mm**
 Packing **20 pz / box**
 Colour **B D**

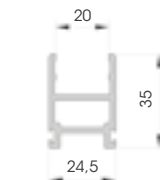

SDH 20

Length **4.000 mm**
 Packing **12 pz / box**
 Colour **B D**

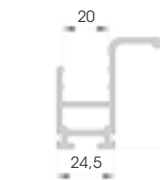

SDHG

Packing **60 mt reel**
 Colour **B D**

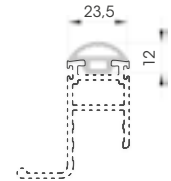

RAIL

Material **aluminium**
 Length **3.000 mm**
 Packing **24 pz / bundle**



WHEEL

Material **steel**
 Packing **100 pz / box**

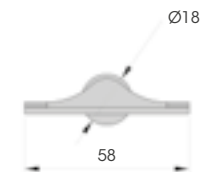

SQ SDF

To install with SDF

Material **aluminium**
 Packing **100 pz / box**

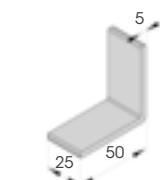

SDW COP

To install with SDW 20 and SDH 20

Packing **100 pz / box**
 Colour **B D**

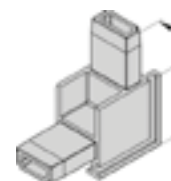

BR 4.5 BR 9

Packing **BR 4.5 1 pz / reel L 600 mt**
BR 9 1 pz / reel L 225 mt
 Colour **D**





TO KNOW OUR NEW **PROTECTION PROFILES** CONTACT US

T +39 049 9301773 - info@mpmpvc.com - mpmpvc.com





PLASTIC PROTECTIONS

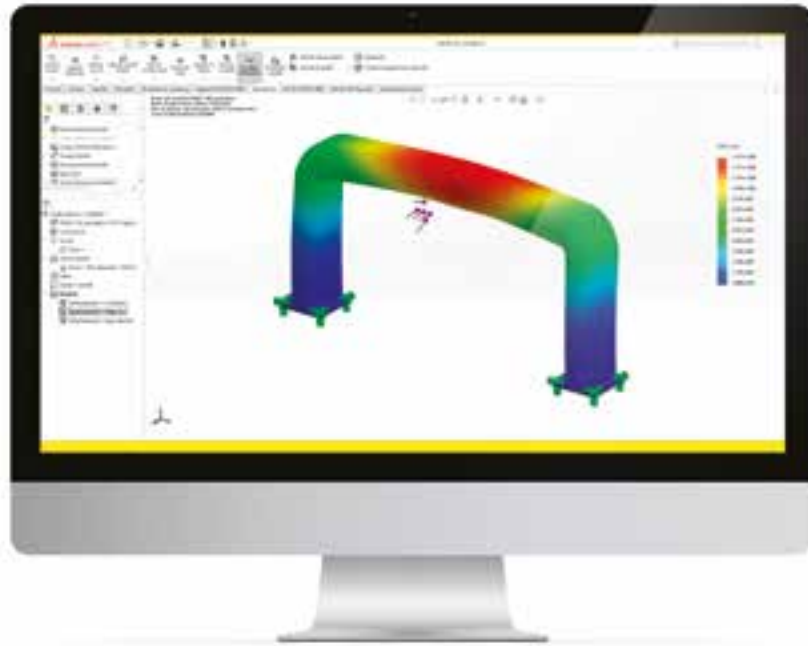

RESEARCH AND DEVELOPMENT

CUSTOMISED PROJECT MANAGEMENT SERVICE



Fixing accessories



TH

ABS.
100 Pcs./ bag.
RAL 9010 / 9002 / 9006 / 7040 / 7024 / Transparent.



TX12

ABS.
100 Pcs./ bag.
RAL 7035 / 9010



TS5

Hole required \varnothing 5
White nylon.
250 Pcs. / bag.



TB14

Hole required \varnothing 4.
Steel / aluminium. / RAL 9010
500 Pcs. / box.



TS7

Hole required \varnothing 5.
White or grey nylon.
250 Pcs. / bag.



TB20

Hole required \varnothing 5.
Steel / aluminium.
500 Pcs. / box.



TS9

Hole required \varnothing 5.
White or grey nylon.
250 Pcs. / bag.



TF14

Hole required \varnothing 5.
Aluminium.
500 Pcs. / box.



TM5

Hole required \varnothing 8.5
Neutral polyethylene.
100/500 Pcs. / bag.



TF20

Hole required \varnothing 6.5.
Aluminium.
500 Pcs. / box.



TM12

Hole required \varnothing 20.
PE, RAL 9010.
100 Pcs. / bag.



TK100

Hole required \varnothing 5 and 20.
Steel screw. Packing on demand.

Colours

A	B	D	E	F	G	H	I	K	L	M	N
RED RAL 3002	GREY RAL 7040	BLACK RAL 9005	WHITE RAL 9010	WHITE RAL 9002	BLUE RAL 5005	GREEN RAL 6029	SILVER RAL 9006	LIGHT GREY RAL 7035	DARK GREY RAL 7024	LIGHT YELLOW RAL 1018	WHITE RAL 9003

Cleaner resistant	Long resistance	Non toxic
Quick assembly	Good waterproof	Class V0 self-extinguishing fire resistance
Shockproof	Easy to clean	
Cheap	Good thermal insulation	
		<input type="checkbox"/> YES <input type="checkbox"/> NO

All pictures are for illustrations purposes only. The company reserves the right to make changes in dimensions, colours, material and packaging without prior notice.

MADE IN
ITALY



M.P.M. s.r.l.
Via Europa 2
35010 Fratte
di S. Giustina in Colle
Padova · Italy

T +39 049 9301773
F +39 049 9300427
info@mpmpvc.com
mpmpvc.com